

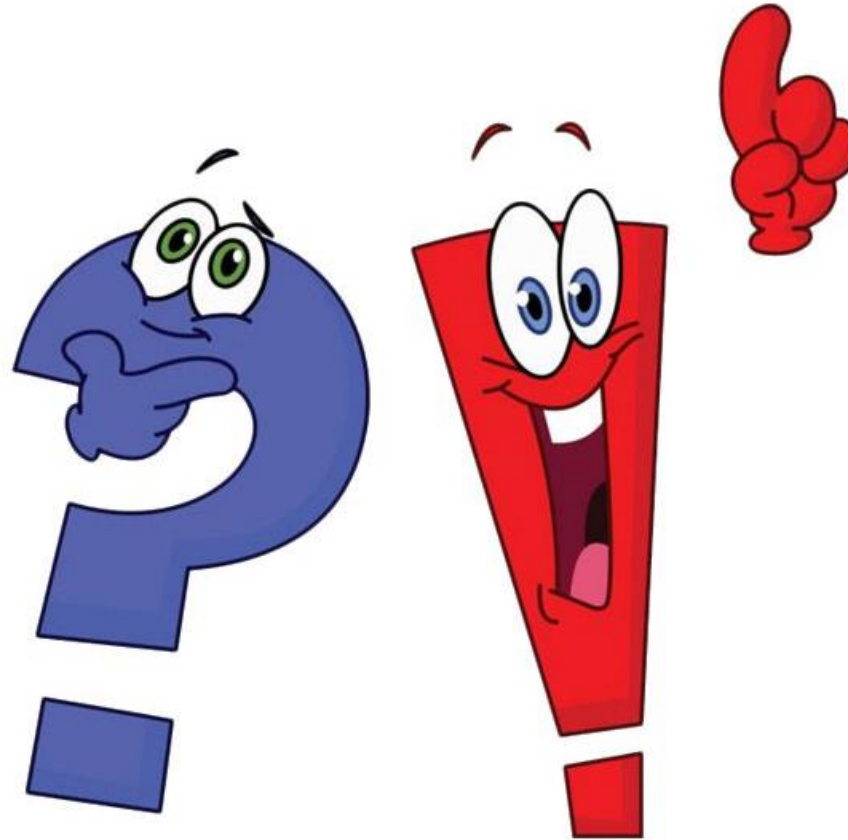

Operation & Troubleshooting



Terms & Insurance Conditions

PLEASE RETURN THIS MANUAL TO THE OFFICE

SUBJECT INDEX

Accident	12 & 20	Fuses (Living Quarters)	44	Seat Belts	14
Air Conditioner	52	Gas Cap light	23	Shower	39
Awning	60	Generator	48	Shuttle Service	68
Battery Disconnect Switch	44	Ground Fault Interrupter	46	Side winds	13
Breakdown	12 & 21	Help Desk	11	Slide room	58
Cab-over Bed	35	Ignition Lock	24	Smoke Detector	19
Campground – Set up & break down	64	Insurance Conditions	8	Terms & Conditions	4
Carbon Monoxide Alarm	18	Introduction	3	Toilet	42
Check Engine light	23	Keys & Doors	32	Traffic Collision	12 & 20
Circuit Breakers	46	Lights (Automotive)	24	Traffic Rules	16
Cook Top	33	Maintenance	21	Transmission	25
Cruise Control	25	Measurement Conversions	65	TV & DVD Player	56
Damages	21	Monitor Panel	33	Vehicle Specifications	66
Dinette Bed	36	Motor Oil	23	Ventilation	36
Driving Safety	13	Mountain Driving	13 & 25	Waste Water System	41
Electrical System – 12 volts	43	Oven (Propane)	34	Water Heater	39
Electrical System – 120 volts	45	Overloading Circuit	47	Water System – Fresh	37
Emergency Assistance	12	Parking Brake	24	Water System – Waste	41
Fire Extinguisher	19	Propane Alarm	18	Windows	36
Flat Tire	21	Rear View Monitor (Ford Transit)	26	Winterization	39
Following Distance	13	Refrigerator	50	Wrench Light	23
Fresh Water System	37	Refueling	13		
Fuel requirement	23	Rental Locations	69		
Furnace (Heater)	54	Repairs	22		
Fuses & Relays (Automotive)	27	Returning Motor Home	67		

INTRODUCTION

Thank you for choosing ROAD BEAR RV / BRITZ USA for your motorhome vacation.

We provide this manual as a guide and it describes the operation of the motorhome equipment in general. Due to differences between similar equipment and motorhome models as well as changes from year to year, we cannot precisely describe every motorhome or its equipment individually. The systems and operation are very similar if not the same. Please read the following information thoroughly.

Your personal walk-through may have been overwhelming or just too much information in a short time. Please take a few minutes and read this manual carefully. Familiarize yourself with the vehicle. This will ensure that you get the best use of the motorhome.

We at ROAD BEAR RV / BRITZ USA are committed to make your vacation as fun and trouble-free as possible. In the event of unanswered questions or a malfunction please call our Help Desk* during business hours (California / Pacific Time).

* Road Bear RV / Britz USA are not liable for any air time, data, roaming or other charges related to phone calls or electronic messages to/from our Help Desk

This document is the property of ROAD BEAR RV and is for informational purposes only

ROAD BEAR RV reserves the right to change the documentation at any time without prior notice. ROAD BEAR RV does not assume any liability for the accuracy of any instructions or specifications contained herein. The document is not intended to describe the specific function of any appliance or item within a particular motorhome. Please assure yourself of the contents and the operation of each item in your motorhome before you leave our rental location. Our employees are able to give you specific instructions. Please ask if you have any questions.

This document is not to be duplicated in any way without written consent by ROAD BEAR RV.

Cover photograph: -

Agoura Hills, CA / February 2019

TERMS & INSURANCE CONDITIONS

GENERAL CONDITIONS

1. INSURANCE

I hereby confirm that I have received and accept the insurance conditions.

2. DAMAGE (VEHICLE CONDITION) REPORT

It is the renter's responsibility to inspect the vehicle for existing damages before leaving our property. All interior and exterior damages (incl. windshield), scratches, dents, etc. need to be marked on the Damage Report Form in order **not to be charged at vehicle return!**

3. COLLISIONS (ACCIDENTAL or OTHERWISE)

In case of a **3rd party collision** with injuries or serious damage to the vehicle(s) you are required to call the police and have them take a report. Take note of the officer's name, ID, the case number and contact information to request the report. Independent of any police report and for minor collisions, the provided Collision Report form has to be completed immediately by the renter and documented with pictures if possible. Road Bear RV / BRITZ USA has to be contacted no later than the next business day. **If 3rd party collisions are not reported on time or if no police report can be provided, the insurance has the right to decline coverage.**

4. SECURITY DEPOSIT

A \$1,000 security deposit (in the amount of the insurance deductible) is due at time of vehicle pick up and based on the credit card company rules, will be authorized for reservations up to 29 nights; for reservations of 30 nights and longer the amount is charged on the credit card. Additional deposits may be required or charged for special events such as a regional festival, "Coachella", "Burning Man", "Stagecoach", "Further Future", "NASCAR", etc. when a surcharge applies or if no mileage has been pre-purchased, etc. Cash deposits are a minimum of \$3,000. Regardless of the customer being at fault or not, before handing out a replacement vehicle, we request from the customer an additional security deposit of \$2,000 charged on the credit card. Such amount will be reimbursed at drop-off (minus any fees/charges).

5. CHILD SEAT

It is solely the renter's responsibility to comply with any and all state or federal child safety seat laws during the rental period. Proper installation according to law and user guidelines in the rental vehicle or shuttle van is the renter's responsibility. Road Bear RV / BRITZ USA does not provide or rent child seats and the use of second-hand seats is at the discretion of the renter. Shuttle transport can be declined if a proper child seat is not provided by the renter. Renters are not allowed to send child seats to our offices. More information on child seats can be found under: safeseats4kids.aaa.com / nhtsa.gov

TERMS & INSURANCE CONDITIONS

6. DRIVING SAFETY

With your signature below you acknowledge the reference of the “**Driving Safety Form**” in the **Renters Manual** and certify your ability and intent to operate the rented vehicle in a prudent and safe manner and in accordance with all laws.

7. VEHICLE SUBSTITUTION

If for any reason the booked vehicle should not be available Road Bear RV / BRITZ USA reserves the right to substitute a higher-rated vehicle at no additional cost. Should a lower-rated vehicle be substituted the Road Bear RV / BRITZ USA liability is limited to the refund of the gross rate difference of the two vehicles.

8. GLOBAL POSITIONING SYSTEM – LEGAL NOTICE

It is your responsibility as the operator and driver of the vehicle to observe safe driving practices and to place, secure, and use the GPS in a manner that will not cause collisions, personal injury or property damage. Do NOT handle or operate the GPS while the vehicle’s transmission is in gear – you should be safely stopped. **NEVER operate your GPS while driving – it is unsafe and dangerous!** The GPS is provided as a navigational aid. Road Bear RV / BRITZ USA and Service Provider do not guarantee the error-free operation of the product nor the completeness or accuracy of the services or any content provided hereon (such as road construction or detours).

Road Bear RV / BRITZ USA and Service Provider do not accept and disclaim any liability for any loss or damage arising out of, or in connection with, the use or inability to use the services or any content. **It is your responsibility as the operator and driver of the vehicle to follow all traffic rules, signs and laws and to assure that the route selected and/or suggested by the GPS is suitable and/or permissible for your type of vehicle, especially in regards to vehicle size, height, width and weight!**

9. MOBILE HOTSPOT - TravelTab

Wi-Fi Hotspot by TravelTab - “The World at Your Fingertips - What you need, when you need it.” TravelTab offers navigation in multiple languages including turn by turn directions, real time traffic details and in the USA and Canada a secure Wi-Fi Hotspot connection for up to 5 devices (unlimited data). International and domestic calling and texting are available at affordable rates (limited minutes/text per day included). Cost to replace device \$499, fix broken screen \$250, loss or damage of any of the accessories \$15 (plus sales tax). Note that the device is non-operational after the return date!

10. RESTRICTIONS

Smoking / Pets: Are not allowed. (Minimum charge of \$250 plus applicable damages).

Death Valley: Traveling into or thru Death Valley is not permitted between June 15 and September 15.

Alaska: Traveling to and within Alaska, Yukon and Northwest Territories is permitted as long as Road Bear RV / Britz USA has been advised at the time of booking.

Mexico: Traveling into Mexico is not permitted.

Others: Traveling on any private, gravel, dirt, fire or logging road and other non-public roads, beaches, etc. is not permitted. Traveling in or through the Inner cities of New York, Montreal and Quebec City (Canada) is not permitted.

TERMS & INSURANCE CONDITIONS

Driving into any (parking) structures – above ground or underground – using any form of drive-thru, drive-in or other covered entry way (such as hotel marquees, etc.) is not permitted. Road Bear RV / BRITZ USA will hold the customer responsible for disregarding these restrictions including collisions, mechanical breakdowns and thefts occurring in a travel restricted area!

11. WINTERIZATION & SNOW CHAINS

Vehicles rented between October 31st and March 31st may be winterized depending on seasonal weather conditions at the rental location or travel destination. If a vehicle is winterized the water system cannot be used. It is the renter's responsibility to ensure the vehicle is winterized (again) when needed. Any damages to the water system are the renter's liability.

All pick-ups from Seattle are required to carry snow chains. The use of snow chains is not permitted due to insurance regulations. If the seal is broken a fee of \$99.00 will apply at drop off – NO Exceptions.

12. TOLLS, PARKING & TRAFFIC VIOLATIONS (TICKETS)

Toll road fees, parking citations, and traffic violations have to be paid before the due date, but no later than at vehicle return. Inform Road Bear RV / BRITZ USA about a ticket if it is due before the return date. With your signature below you authorize Road Bear RV / BRITZ USA to charge your credit card for any fines, all late fees and a \$100 administrative fee per incident for any ticket not paid on time or at vehicle return.

13. FUEL & PROPANE

The cost of fuel (gasoline) and propane is not included in any rental rate and Road Bear RV / BRITZ USA does not assume responsibility for estimates of consumption. All vehicles are delivered with full tanks and the customer is expected to return the vehicle with full tanks or will be charged accordingly.

14. MAINTENANCE AND REPAIRS

Maintenance: The customer is responsible for checking the engine oil and coolant levels at each refueling stop as well as reporting mechanical failures immediately. An oil change is required every 5000 miles driven after vehicle pick up. Coolant refills, oil changes, and authorized repairs will be reimbursed upon return of the vehicle and presentation of all receipts (see mechanical breakdown). It is the driver's responsibility to operate the vehicle in a safe manner and to exercise all caution possible. Generator oil needs to be checked every 8 operating hours. For maintenance and repairs exceeding \$50 the customer must call the Road Bear RV / BRITZ USA Help Desk to get an authorization. Non-authorized repairs over \$50 will not be reimbursed. Receipts and replaced parts must be presented for reimbursement. Customer will be held responsible for mechanical damage due to negligent operation and/or lack of maintenance.

Repairs: Unauthorized repairs of the vehicle and its equipment over \$50 will not be reimbursed. Receipts and replaced parts need to be presented for reimbursement. The renter will be held responsible for mechanical damages due to negligence in operation and/or lack of maintenance.

TERMS & INSURANCE CONDITIONS

15. MECHANICAL BREAKDOWN / TECHNICAL DIFFICULTIES

While our first and foremost priority is to provide excellent and high quality vehicles and service, unexpected technical difficulties can arise. To ensure that you can enjoy your motorhome experience we provide an extensive vehicle explanation and an operations manual with every vehicle, as well as our Help Desk phone number which is free of charge from any landline in the USA. Please note: We are not returning phone calls or accepting requests to call you back because you may be hiking, visiting a museum, etc. and not at the vehicle when we call. **Road Bear RV/Britz USA are not liable for any air time, data, roaming or other charges related to phone calls or electronic messages to/from our Help Desk.** You should call when at or near the vehicle. We further differentiate between an inconvenience and an emergency:

An Emergency is: when the motorhome cannot be driven safely anymore. An example is when the engine stopped working. In such a case the Vacation Interruption (VIP) Insurance applies (see point 1 - Insurance)

An Inconvenience is: the failure of comfort equipment – such as the DVD player not working or the slide-out not extending and therefore the interior space not increasing, things that require you to spend additional time, a workaround or a non-safety related feature that is not available. For example: purchasing ice because the refrigerator is not cooling. (For details see the VIP section of point 1 – Insurance)

16. REFUNDS/REIMBURSEMENTS

There are **no refunds** for unused rental time, unused mileage, unauthorized repairs, and/or repairs without a receipt.

17. COMPLIMENTARY SHUTTLE TRANSFER

A complimentary shuttle transfer is provided at all rental locations, once a day, to the airports DEN/EWR/LAS/LAX/MCO/SEA/SFO and to/from named airport hotels. Our permitted amount of luggage in accordance with the airline regulations for economy passengers is one suitcase (max. 50 lbs./23kg) plus two pieces of hand luggage per person. Excessive luggage (bicycle, child seat, wheel chairs) is the customer's responsibility. Parents are responsible to provide a child or booster seat according to applicable laws (see point 5 - CHILD SEAT).

18. CHANGES TO THE RENTAL AGREEMENT

Early return: Early returns are possible Monday thru Friday no later than 4 pm, Saturdays no later than 12 pm. There are no returns on Sunday or Holidays or outside regular business hours. The main renter needs to be present at time of vehicle return. There is no key drop or parking in front of our properties.

Extension: To extend your rental, you need to contact the return (drop off) location in writing no later than 72 business hours before the scheduled return. Extensions are only possible based on availability of the same vehicle category. Unauthorized extension are charged by the current daily rate and a \$300 handling fee per day.

Other location: For an unauthorized return at a location different than stated on the rental agreement additional fees (minimum \$2/mile & flight) are due to cover the transport of the vehicle to the correct drop off location.

TERMS & INSURANCE CONDITIONS

19. STORAGE, LOST & FOUND

Road Bear RV / BRITZ USA does not assume any liability for any damaged, lost or stolen personal property and items left behind in the vehicle or left/stored at our facilities.

20. VEHICLE RETURN

Time & date: The vehicle return begins at **8:00 am and needs to be concluded by 10:30 am** (11:00 am if the shuttle transfer is not needed) on the date & location stated on the rental contract.

Cleanliness: The vehicle needs to be wiped & swept inside, waste water tanks emptied and the fuel and propane tanks full and **garbage needs to be disposed to prevent being charged additional fees at the return location.**

Late return: For an unauthorized late return after 11:00 am the sum of the actual nightly gross rental rate plus \$300 for administration and handling will be charged for each day late.

Office hours: Vehicles cannot be returned outside our office hours due to the checkout procedure and final charges (see point 18).

Non-return: Should the vehicle not be returned at the designated location, the cost for transferring the motorhome to the proper location will be charged.

Shuttle Transfer: Complimentary transfers are provided once a day at 11:00 am to the airports DEN/EWR/LAS/LAX/MCO/SEA/SFO and to listed airport hotels. **No transfer will be provided for vehicle returns not concluded at 10:30 am.**

INSURANCE CONDITIONS

PUBLIC LIABILITY INSURANCE (included in the daily rate)

The Public Liability Insurance covers a 3rd party collision in the event that the renter is at fault. The insurance has no deductible. The policy protects the rental company up to US\$ 1,000,000 and the renter to Statutory Limits (state mandated minimum liability coverage which can be changed by a state anytime without notice – you find the current limits online). Liability Insurance has no deductible and the current minimal coverages by state can be found on this website:

<https://drivinglaws.aaa.com/tag/liability-laws/>

SLI (SUPPLEMENTAL LIABILITY INSURANCE)

The optional SLI coverage provides the customer with an increased limit of liability protection. SLI increases the coverage over the state mandated minimum liability limits for the renter and any authorized driver listed on the rental agreement to US\$ 1,000,000 against 3rd party damage claims.

TERMS & INSURANCE CONDITIONS

PREMIUM VIP COVERAGE (included in the daily rate)

Premium VIP coverage includes secondary comprehensive and collision coverage for the rented vehicle with a deductible of US\$ 1,000.00 per incident. Security deposit required: \$1,000.00 (per credit card). Coverage includes but is not limited to:

- “Uninsured Motorist” in case the renter is involved in an accident with a non-insured driver
- Accidental damages to the vehicle (renter’s or 3rd party’s fault)
- Windshield, glass or tire damage
- Vehicle theft and fire (personal belongings are always excluded)
- Vandalism

No insurance coverage is provided (liability or comprehensive & collision) while traveling into non-authorized areas including but not limited to the country of Mexico, the inner cities of New York, Montreal and Quebec (Canada).

VIP (Vacation Interruption Protection)-Coverage reduces the deductible for theft and accidental damages (also if renter is not at fault) to \$1,000 per incident (exceptions: “non-covered damages”). Personal belongings are never covered. If the renter's motorhome vacation is interrupted by an automotive mechanical breakdown (not collision or damages caused by others or the renter) for more than 12 business hours after reporting such incident to Road Bear RV / BRITZ USA, the renter will be reimbursed for the greater of: (1) the gross daily rate or (2) expenses for hotel rooms up to \$25 per person per night and car rental up to \$50 per day per motorhome up to a maximum of \$1,500 per trip. Receipts for all incurred expenses must be presented for a refund. Defective comfort equipment such as radio, TV, DVD, CD, Bluetooth, USB, GPS, Wi-Fi (TravelTab), generator, batteries, air conditioner, refrigerator, furnace, water heater, cruise control, awning, slide-out, etc. are not considered mechanical breakdowns and are excluded from VIP reimbursement.

Non-Covered Damages

No liability, comprehensive or collision insurance coverage is provided and the customer has full legal and financial responsibility in case of:

- Damages to the interior of the vehicle
- Personal injury, personal items and property
- Carrying more passengers than having seat belts available
- Deliberate or willful damages caused by the renter or his guests
- Damages caused to the vehicle by abuse or misuse for illegal activities
- Damages where the customer is charged by the local authorities for being careless
- Damages caused by freezing, e.g. unit not winterized, or overheating of vehicle or systems

TERMS & INSURANCE CONDITIONS

- Driving the vehicle without a rental agreement, in breach or violation of the rental agreement or by non-authorized drivers
- Damages and accidents caused under the influence of alcohol, drugs or any other controlled substance
- Damages and injuries caused by neglecting proper operating procedures, e.g. incorrect fuel type or quality, ignoring oil or coolant levels, air pressure, etc., by overloading the vehicle and/or exceeding the legal towing capacity (towing limit is with proper equipment 1,500 lbs. – enclosed trailers, boats or vehicles are not allowed)
- Damages where the customer is showing gross negligence or willfulness in failing to abide by the local laws and rules or disregarding common sense resulting in damage to the vehicle or third-party vehicle or property
- Operation of the vehicle by anyone not meeting the age requirements or not listed on the rental agreement or not having a valid, original driver license
- Damages and losses due to “off-road” usage, or caused during travel in or thru restricted areas, following incorrect GPS guidance, traveling into non-authorized areas including but not limited to the country of Mexico, the inner cities of New York, Montreal and Quebec (Canada)
- As per our insurance conditions, we do not recommend tailgating (following too closely). Please keep a safe distance of at least 500 feet from the vehicle in front of you at all times

Please take note: In case of a claim, Road Bear RV / BRITZ USA will not act as an adjuster for any third-party insurances purchased by the renter (such as zero-deductible insurance, etc.)

HELP DESK

In case of an operational or technical problem and after consulting this manual, you can contact our Help Desk for assistance during business hours

Mon. – Fri. 8:00 – 5:00, Sat. 8:00 – 1:00, Pacific Time

Keep in mind that most repair centers have business hours and are closed on weekends and Holidays

The phone numbers are located on the key tag

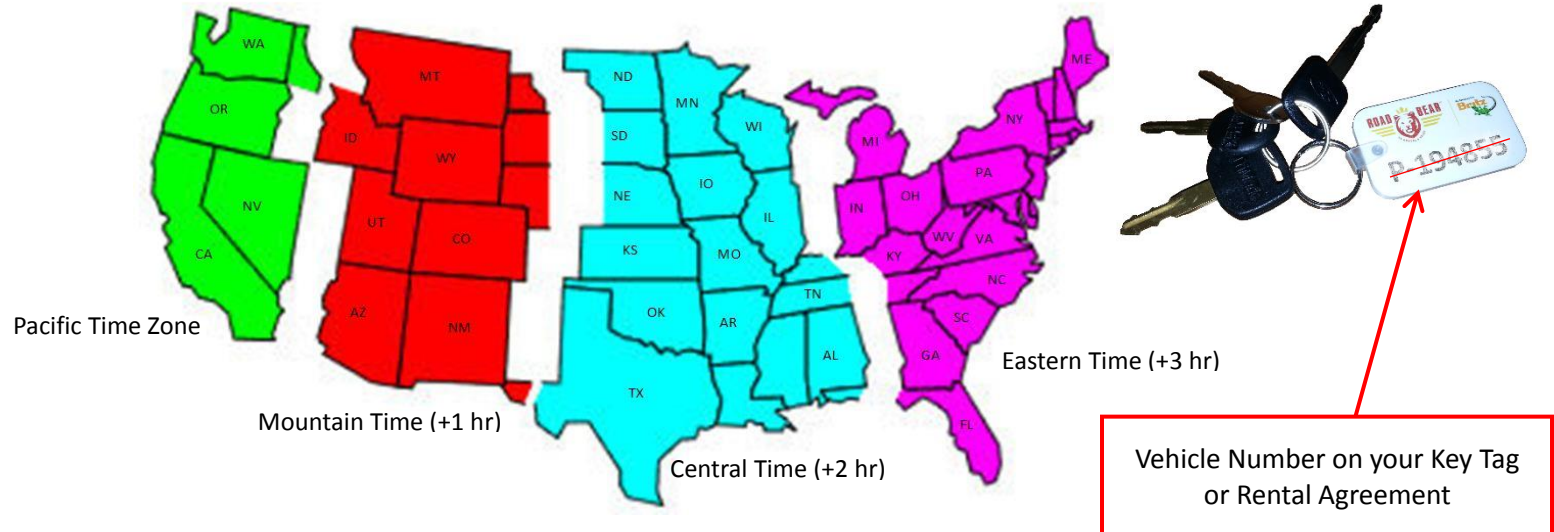

You can also contact us by e-mail for operational questions or to report collisions.



Please include your Vehicle Number (as listed on the Key Tag & Rental Contract) in the subject line.

VEHICLE NUMBER	P-109599	RENTAL AGREEMENT	B-LAX-29195
YOUR PICK-UP STATION		YOUR DROP-OFF STATION	
Road Bear RV	1-866-527-6875	Road Bear RV	1-866-249-1119
C/O Coachmen RV	Middlebury, IN 46540	847 Industrial Pkwy West	Hayward, CA 94544
423 Main Street			
Pick Up: Mo-Fr 8 am - 4 pm	Sa & Su closed	Pick Up: Mo-Fr 12 pm - 4 pm	Sa 12 pm - 1 pm
		Drop Off: Mo-Sa 8 am - 10:30 am	

To assist you we may have to ask questions or give you multi-step instructions, for which e-mail is not practical and will delay effective help. Please understand that we are not always able to return phone calls.

* Road Bear RV / Britz USA are not liable for any air time, data, roaming or other charges related to phone calls or electronic messages to/from our Help Desk

Collision or Break-down



Flat tire, keys locked in or lost, out of fuel, engine or transmission problems, which prevent you from driving



Should you experience any kind of emergency that requires immediate professional medical assistance, fire or police

assistance please call the nationwide emergency number  **911** from any nearby telephone. Should you be involved in a vehicular collision, call the local police/sheriff/park ranger and inform us no later than the next business day to maintain insurance coverage – see page 14 for more details.

Should your motorhome no longer be drivable, call us at the numbers on the key tag or rental agreement.

**An emergency is when the motorhome cannot be driven anymore
Please call the numbers on your key tag**

24 hours a day – 7 days a week

All other calls 8:00 a.m. – 5:00 p.m. Monday – Friday (Pacific Time)

800/855/866/877 & 888 phone numbers are toll-free* which can be called from any landline phone!

* Road Bear RV / Britz USA are not liable for any air time, data, roaming or other charges related to phone calls or electronic messages to/from our Help Desk

DRIVING SAFETY

Be aware that you are driving a much larger and heavier vehicle than a car. This will cause the vehicle to react differently from what you may be used to. Failure to follow this safety information may result in an accident, injury or death. **Obey all local, state and federal traffic laws.** Plan your route in advance and know the vehicles dimensions and limitations!

Refueling (Gasoline and Propane)



Refueling of gasoline and propane **releases highly flammable fumes.** It is therefore mandatory to **TURN OFF** any spark emitting appliances (engine, refrigerator, water heater, furnace, etc.) before fueling. Turn off the engine and the battery disconnect switch by the entry door. **Turn it back ON after fueling.**



Side winds



SLOW DOWN!

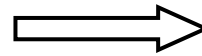

Use caution or stop if necessary when traveling in high wind conditions. Do not ignore wind warnings on the radio or by traffic officers. When trucks park along the road – stop as well.



Following distance



5

4

Distance in seconds:

3

2

1



The braking distance is much greater than for a car. **Keep a greater distance to the vehicle in front of you!** If you follow a truck, keep extra distance to reduce risk of damage to the windshield by stones thrown up.

Mountain driving

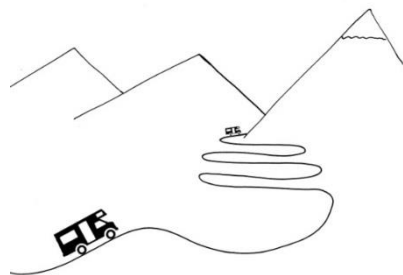

When driving in the mountains engage the transmissions tow/ haul mode (separate button). This setting will provide improved pulling power for uphill and engine braking with transmission downshifts for downhill driving. To prevent brake overheating engage the tow/haul mode any time extra braking is required. Higher engine speed and noise are normal in tow/haul mode.

Adjust your speed according to current road and traffic conditions!

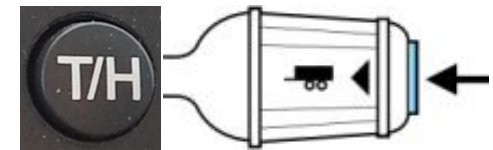

Driving at night



If you are driving at night, be aware that in many rural areas (especially in the wide open areas of the western states) wildlife and in some areas livestock can be encountered on the roads. **Adjust your speed accordingly.**



Seat belts



All passengers in the motorhome need to be buckled up. Children - typically up to age 6 or 60 pounds – need to be in a child or booster seat. Consult state regulations – see our website for further details.

DO NOT get up, cook, shower, use bathroom, walk around or lie on any bed in the motorhome while the vehicle is in motion!

The safety of yourself and your loved ones is very important.

GPS – Navigation System

NEVER operate any GPS device while driving – it is unsafe and dangerous! Do NOT handle a GPS while the vehicle transmission is in gear – stop and park before operating a GPS. Install and use a GPS device in such a manner that does not cause accidents, personal injury or property damage.



Overhead obstacles



Watch for low overpasses, low-hanging trees, roof edges and road signs. If needed, have a passenger step outside and guide you past the obstacle. Required vertical clearance for Class C is 12 feet (3.65m) and for Class A is 13 feet (3.95m).

Entering parking structures is **PROHIBITED!**

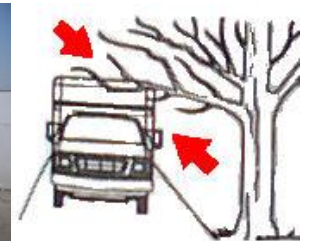
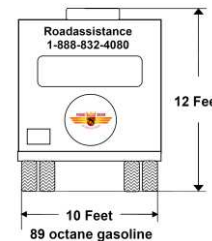

Driveway entrances and rough road surface

Enter and exit driveways **SLOW** and at an angle – the rear of the motorhome could hit the ground. Drive slowly over ramps, humps, bumps, rough ground and other obstacles of any kind.

CAUTION - Cabinets could open and objects fall out!

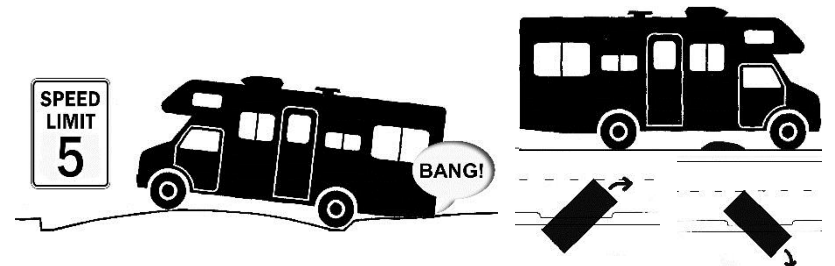

Maneuvering & parking

Due to the vehicle length, turns need to be executed with extra caution. Turning too soon or too tight may lead to a collision with obstacles. Check your mirrors and drive slow during maneuvering.

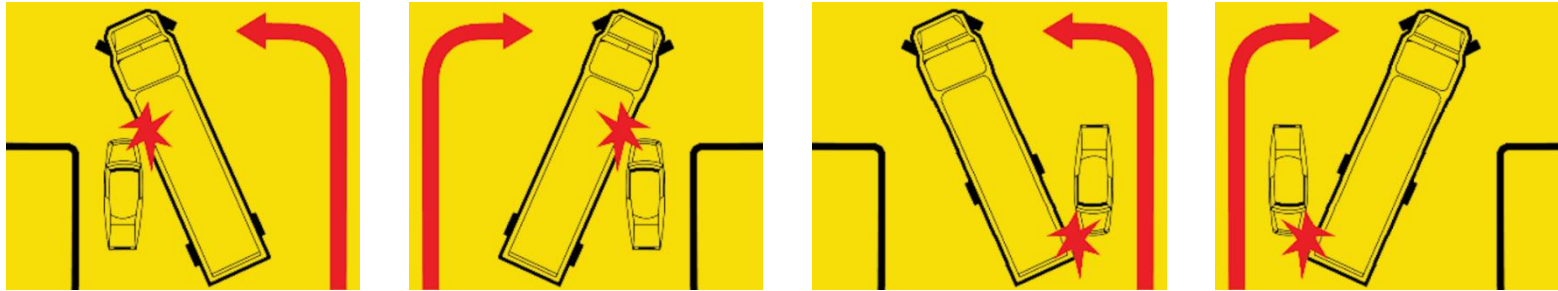

The rear of the motorhome swings out wide and clips corners when making turns. Allow for extra room when making turns and parking. Ensure the rear wheels also clear any obstacles.

Park in an area with a lot of free space and use more than one parking spot if possible to ensure other cars do not park too close. You are responsible to pay for all parking spaces used! Parking structures are **PROHIBITED!**

When maneuvering on a campground or parking lot **ALWAYS** get help from a passenger → *do not rely on* mirrors or backup cameras only! Have someone outside of the motorhome checking for overhead- & side-clearance and obstacles.

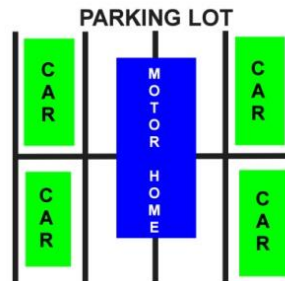

Backing up (Reversing)

ALWAYS get help from a passenger while backing up → *do not rely on* mirrors or backup cameras only! Have someone outside of the motorhome checking for overhead- & side-clearance and obstacles. Even if the motorhome is equipped with a rearview camera - there remain blind spots!

Damages caused by backing up are gross negligent and NOT covered by the insurance!

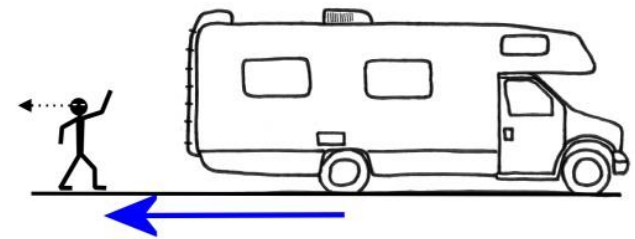

Tunnels and narrow roads

Drive slowly in tunnels and on narrow mountain roads. Many roads in National and State Parks have been built long before motorhomes were common vehicles. If you slow down when roads narrow, you are more likely able to avoid a mirror-to-mirror or other collisions.

Mobile phone use while driving



It is not just **unsafe** to use a cell phone while behind the wheel, but in most states it is **illegal!** If you have to make a call – pull over or have a passenger make the call.



Loose items

Secure any loose items or equipment before you drive off. In case of an accident or emergency stop, such a loose item could cause severe injury.

Break-in and theft



Motorhomes can be a target of thieves. Keep all doors locked while the vehicle is in motion. Do not leave valuables like cameras, computers, etc. laying out where they can be seen. To prevent somebody from hiding in the vehicle, lock all windows and doors; open all curtains and remove the privacy curtain when leaving the motorhome. This helps the police/security personnel to spot suspicious activities.

Should you have fallen victim to a theft or break-in, call the police and get a police report for your insurance.



Emergency exits

Emergency exits are clearly marked. Special window exits are not to be opened - except in emergencies.

Hot surfaces

Exhaust ports of furnace, water heater and generator are extremely hot when in use. Do not touch!

Slippery when wet

Entry steps and floors can be slippery when wet. Watch your step! Showers are very slippery when wet and not for use while vehicle is in motion.



Risk of falling

- The cab-over bunk bed is above the cockpit and one could fall out of bed. **ALWAYS use the safety net when small children sleep in the cab-over bunk**
- Watch your step when exiting the vehicle. If the motorhome is equipped with an entry step and it is retracted you could fall and get hurt. Electric step: wait until the step is fully extended before you step outside
- **For safety reasons, renters is not allowed access the roof area!**

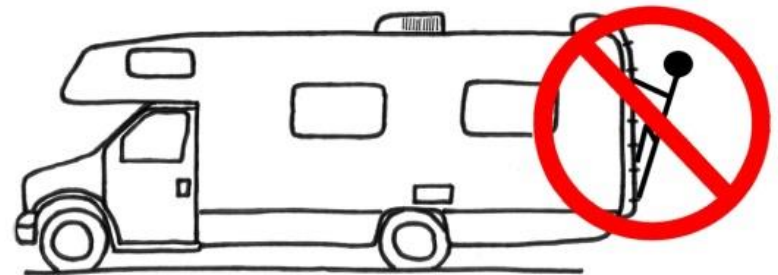

Traffic Rules

There are some unique traffic rules in North America, not commonly encountered elsewhere. Road signs are often spelled out.

Emergency vehicles

If an emergency vehicle on duty is approaching from either direction with its siren and warning lights on, **you are required to pull over to the right side of the road and stop** until the emergency vehicle has passed.



Traffic stop



If a police car is following you with its flashing lights on, you have to pull over in a safe place as soon as possible and stop. Do NOT exit the vehicle and keep your hands visible for the officer.

Follow the officer's instructions and answer all questions.

If you are issued a traffic ticket, call ROAD BEAR RV for further instructions.

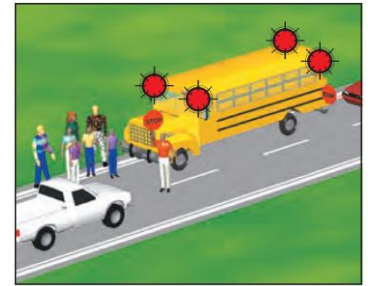

School bus

If you encounter a stopped school bus with its red lights blinking **you are required to stop fully until the lights are turned off.** You have to stop from either direction if there is no raised center divider between the traffic lanes.

Traffic lanes

Passing: Only on a broken line on your side of the road. Only pass if there is no oncoming traffic. **The motorhome is heavier, longer and slower than a car and needs more room and time to pass another vehicle.**

Turning: If there is a center lane, you may use it to make a left hand turn. You may also use the center lane when entering traffic.

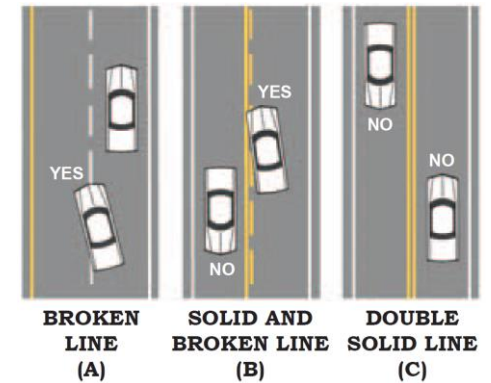
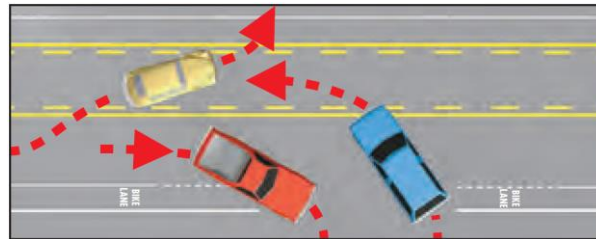

Hand signals

Should the turn or brake lights fail, you are required to signal your intentions by hand.

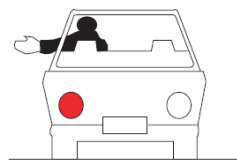

**LEFT
TURN**

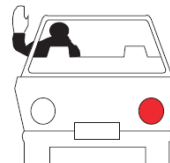

**RIGHT
TURN**



**STOPPING
or SLOWING
ABRUPTLY**

These traffic rules are by no means complete and all traffic laws are applicable.

MOTORHOME SAFETY EQUIPMENT

PROPANE & CARBON MONOXIDE DETECTOR

Carbon Monoxide is an odorless gas often caused by burning. Propane is very flammable, heavier than air and smells like rotten eggs. It is used for heating, cooking and refrigeration. For your safety, a propane & carbon monoxide detector is installed in each motorhome often near the kitchen - just above the floor. Green (blinking) light = Normal. Blinking red or red/green light = Error – have it checked before you stop for the night! Red (blinking) light and fast loud high pitch chirping = Danger - high propane or carbon monoxide levels. Proceed immediately with the following steps:

1. Turn off all open flames – **do NOT touch electrical switches (potential sparks!)**
2. Exit the vehicle immediately and close the main valve on the propane tank
3. Turn off the battery disconnect switch at the entry door
4. Wait several minutes before re-entering the vehicle
5. Open windows and the entry door - allow the propane/carbon monoxide to fully dissipate
6. Ensure the stove and oven burner valves are closed; turn off the water heater, the furnace, refrigerator and generator
7. Reset the alarm by pushing the test/mute button – blow into the opening
8. Turn the main valve on the propane tank back on – if you smell propane again – turn it back off and call our Help Desk
9. If you do not smell propane and the alarm does not go off anymore, the source of the leak may have been a temporarily open valve at the cook top

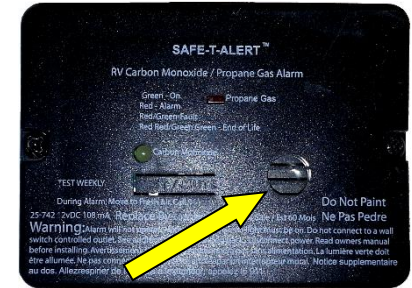

Certain cleaning solvents, aerosol sprays, dust and camp fire fumes can also trigger the alarm. Blowing into the sensor can help to clear it out.

TROUBLESHOOTER		
CO detector alarm going off	CO in coach	Open all windows - turn off engine and/or generator
CO detector "chirping"/60 sec.	Low coach battery voltage	Recharge coach battery by starting engine
Propane detector alarm going off	Possible propane leak in system	See steps above
	Cleaners or fumes activating alarm	Press mute/test button, blow into the alarm and air out motorhome thoroughly
Propane detector "chirping"/60-90 sec.	Low coach battery voltage	Recharge coach battery by starting engine
Foul egg smell in and/or around motorhome	Possible propane leak	- See above steps - Have the gas system checked and leak repaired before using again - Call Help Desk
	After recent refilling of propane tank: Vapor valve not fully closed	Close Vapor valve on propane tank completely

SMOKE DETECTOR & FIRE EXTINGUISHER

Every motorhome is equipped with a fire extinguisher near the entry door. The smoke alarm is mounted to the ceiling, usually near the kitchen. The alarm sounds off a very shrill beep if it detects smoke – indicating a potential fire. Sometimes, cooking will also make the alarm to sound – please make sure you only cook with an open window and the range hood or roof vent fan running.

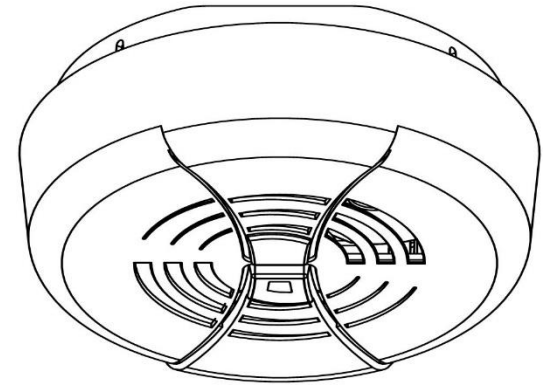

If the alarm sounds, proceed with the following steps immediately:

1. Turn off any propane appliance – cook top, furnace, etc.
2. Extinguish any visible flames, using the fire extinguisher
3. If the fire cannot be extinguished, exit the vehicle immediately. Turn off the battery disconnect switch and close the main valve on the propane tank
4. Get help – call the fire department ☎ 9-1-1!
5. Once everybody is safe and the fire has been extinguished, call our Help Desk for further assistance

If there was no fire, open a few windows and get fresh air thru the motorhome. To reset the alarm push the test button until it beeps.

A regular low pitch beep about every 60 – 90 seconds indicates low battery voltage.



TROUBLESHOOTING		
Smoke alarm going off	Smoke & fumes while cooking	Turn on range hood/roof vent fan and open some windows. Push mute/test button on alarm
	Fire in motorhome	Close main propane valve. Call 911 and use fire extinguisher
Smoke detector “chirping”; 60-90 sec.	Battery voltage low	Replace battery

VEHICULAR COLLISION – ACCIDENT

An accident is a vehicular collision in traffic and/or with property resulting in injury and/or damage to others and/or their property. Collisions without harm and/or damage to others and /or their property are designated as damage (see next section).

1. Get to safety if situation is dangerous
2. Make sure everybody is okay – administer first aid
3. Call the local police and have an officer take a report. **In case of injuries dial 911 (ambulance, police or fire department).** Request the officer’s name, ID-, case number, phone number and how to get a copy of his report. If the police refuses to come or take a report; get the name, ID number and local phone number of the officer answering your call



For minor accidents or on private property, the police usually does not take a report. Proceed with step 4 below

4. Take pictures of the accident scene and the involved vehicles – if possible before moving the vehicles. If the vehicles were moved take pictures of the accident area as well
5. Exchange all information with the other party and fill in the Road Bear RV collision report form. It is necessary to provide the information from the other party – name, address, phone number, insurance information – if the other person refuses, call the police. Only a police report alone is not enough!



The collision report form, registration and insurance information are located in the pouch in the glove box on the passenger side

6. Road Bear RV / BRITZ USA must be contacted no later than the next business day at our Help Desk (phone number on the key tag) or at help@roadbearrv.com
7. E-mail the accident report (high resolution pictures) or fax it from the next campground

The insurance company has the right to decline coverage if accidents are not reported on time or if no collision report can be provided.

Please arrive before 09:30 a.m. on your return day to process the formalities





ROAD BEAR
RV RENTAL & SALES



By **Britz**

Collision Report



Type of incident: 3rd party collision (with other vehicle or property) Single party collision

 = take a photograph of documents/damages/situations

DAMAGES

In case the motorhome got damaged without harm to people and/or damage to property of others, please report the damage to the Help Desk (key tag) or help@roadbearrv.com and to get assistance in having the vehicle repaired - if needed.

Please arrive before 09:30 a.m. on your return day

		<h3>Collision Report</h3>
Type of incident:	<input type="checkbox"/> 3 rd party collision (with other vehicle or property)	<input type="checkbox"/> Single party collision
	 = take a photograph of documents/damages/situations	



FLAT TIRE



Do NOT drive with a flat tire! Even if there is a second tire on the same side, driving with a flat tire will overload the other tire and is dangerous. In case you have a flat tire please call our Help Desk for assistance. Please have the following information available: a) miles, b) which tire and c) the exact street address. We will arrange for professional help to install the spare tire. Repair or replacement cost of the flat tire is your responsibility within the insurance deductible. For safety, insurance & liability reasons there are no tools in the vehicle.

BREAKDOWN

Should the vehicle break down – not drivable anymore – call our Help Desk. Please have the following information available: a) miles, b) problem description, c) number of passengers and d) the exact street address. Unauthorized towing will not be reimbursed.

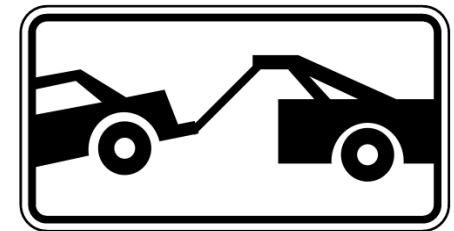

MAINTENANCE

You as renter are responsible for the maintenance of the rental vehicle during the rental period. Check the engine oil and coolant levels every two days. A motor oil change is required every 5,000 miles you drive. Maintenance expenses in excess of \$50.00 will be reimbursed with prior approval by Road Bear RV / BRITZ USA and with receipt only. Oil changes can be done at any nationwide lube centers such as Jiffy Lube/Quick Lube/EZ-Lube or similar. You are **not** required to have the oil changed by a Ford or motorhome dealership, those are usually overpriced.

Motor oil is best checked with a cold engine on level ground. The oil level has to be between the MIN and MAX mark. NEVER fill more than ½ quart/liter at one time! Recheck after 2 minutes after adding oil and before filling more.

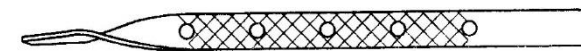

Inspect the oil level in the generator **every 8 hours of usage**. Damages due to lack of maintenance are the renters responsibility. Use regular motor oil if needed.

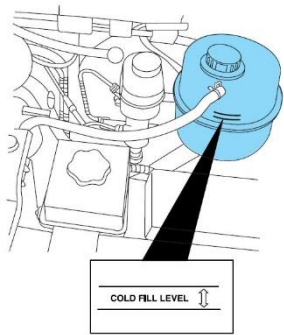

Coolant level



Oil grade

Generator oil level

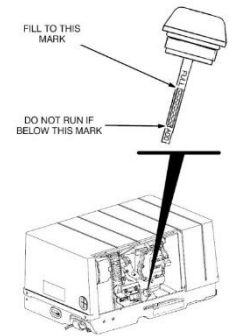

The engine coolant has to be inspected regularly when the engine is cold and if needed, add drinking water only.

Have the tire pressure checked weekly. Pressure information is found on the blue Ford label near the driver seat – usually on the door frame.

REPAIRS



If there is a defect and you are close to a Road Bear RV facility, please call ahead for an appointment. Addresses and phone numbers can be found on page 69. Our staff is best qualified and equipped to get the problem resolved quickly.

We do NOT offer repairs off-site (on campgrounds, etc.).

Any on-the-road repairs that are **more than US\$ 50.00 require prior authorization** by Road Bear RV. For authorization call our Help Desk. Non-authorized repairs will NOT be reimbursed.

Mobile repair service is generally not authorized.

If you need a repair, have the repair shop a) diagnose the problem and prepare a repair estimate, b) have the repair shop contact our Help Desk for repair authorization & payment, c) record the vehicle number, VIN, current mileage & appliance serial# (if applicable).

Please show the back side of your document folder to the repair shop with these instructions.

Repairs will be paid directly by Road Bear RV to the repair facility – you are required to return any defective parts. To get reimbursed for repairs, receipts and defective parts need to be returned to Road Bear RV. Non-authorized repairs and repairs without a receipt will NOT be reimbursed.

Most repair shops have regular business hours and are usually closed on weekends and holidays. Some are closed during the winter season.

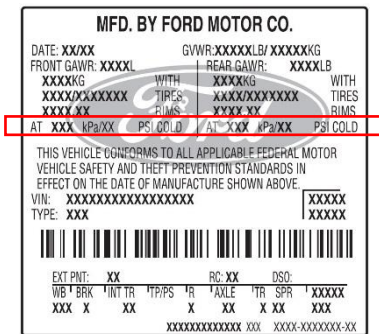

AUTOMOTIVE EQUIPMENT (FORD)

FUEL REQUIREMENT



The motorhome requires 89 octane grade **unleaded gasoline**. If 89 octane fuel is not available use the next higher grade.

Maximum 5% Ethanol blend (E5)!



MOTOR OIL



The motor oil grade is indicated on the filler cap in the engine compartment. Vehicles oil level needs to be inspected every 500 driven miles and the generator oil level every 8 hours of generator operation. NEVER fill more than ½ quart/liter at one time! Always wait 2 minutes after adding oil and before filling more.

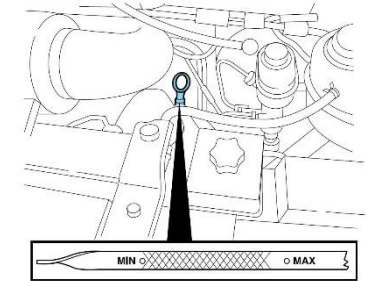
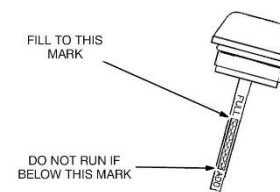

GAS CAP LIGHT



If the gas cap light turns on; open and close the gas cap and you can drive on. The computer will need a few days (variations of driving cycles) before turning the light off.

CHECK ENGINE LIGHT

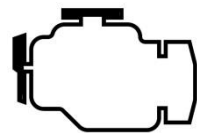

If the check engine light turns on and there are no changes in engine performance (such as lack of power, extra engine noise or vibrations) you can drive on. The computer will need a few days (driving cycles) before turning the light off.

If you notice any change in performance, noise, vibrations or otherwise – call the Help Desk.

If the light is **flashing (blinking)** stop as soon as possible in a safe place to prevent engine damage and call the Help Desk.

WRENCH LIGHT

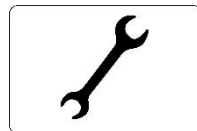

If the wrench light turns on and there are no changes in vehicle operation (such as loss of power, extra noise or vibrations) you can drive on. If you notice any change in performance, noise, vibrations or otherwise – call the Help Desk.

If the light is **flashing (blinking)** stop as soon as possible in a safe place to prevent engine damage and call the Help Desk.

PARKING BRAKE



Stop the vehicle fully and apply the parking brake (1) before shifting the transmission into 'Park'.
To release the parking brake, pull the marked handle (2).

Some vehicle models have a hand operated parking brake

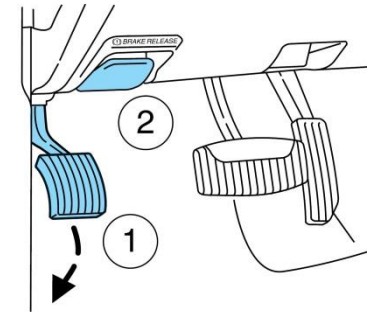

LIGHTS

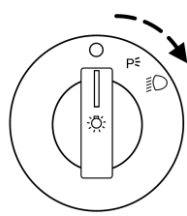

Headlight & parking light control switch is located to the left of the steering wheel

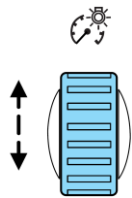

Instrument panel (dashboard) illumination – turn wheel up or down or push appropriate buttons to adjust

Some reading (dome) lights: ON → rotate wheel all the way up and/or push on the lamp; OFF → rotate wheel down and/or push on lamp. Some vehicle models have a switch on the lamp itself or next to it



For high beam push the turn signal lever forward

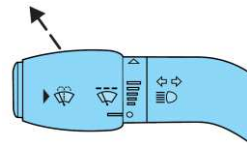

IGNITION LOCK

Turn the key clockwise to start the engine

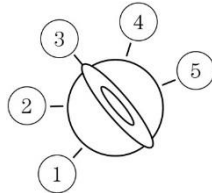

- 1/B – Radio/Accessory position
- 2/A – **Remove key position**
- 3/A – OFF position
- 4/C – Ignition ON position
- 5/D – START position

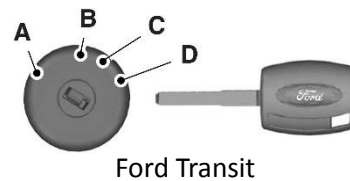

Ford Transit

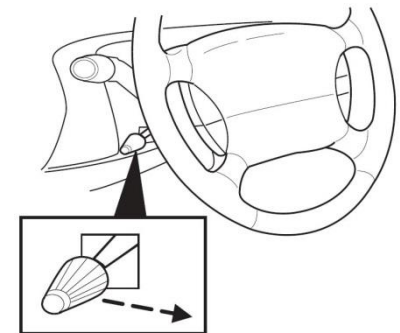

Ford E-Series & Class A

TROUBLESHOOTING		
Cannot remove ignition key	Gear not in Park position	Put gear in Park position
	Key not in correct position	Turn key to the remove position

TRANSMISSION

P R N  3 2 1

Gearshift: Depress brake pedal  to shift out of 'Park'. Gear lever: pull towards you and down to engage transmission. Use 'D' for regular and uphill driving. NEVER start from a complete stop in 1st, 2nd, 3rd or 4th gear – the transmission will not automatically shift! For very steep declines and in extreme cases, at speeds below 20 mph (30 km/h) only, shift down

to 3rd/4th gear if needed. A simple rule of thumb: if you have to use the brakes a lot, activate the tow/haul mode or shift down!

Ford Transit: **do not drive in M (Manual) mode** – transmission will not shift automatically – overheating and damage possible!

TROUBLESHOOTING		
Cannot get shifter out of park	Ignition off	Start engine
	Brake-shift interlock feature on	Depress brake pedal with right foot Replace fuse

MOUNTAIN DRIVING

Tow/Haul—normally OFF. Tow/Haul ON → use this position when driving in the mountains. This will provide improved pulling power for uphill and engine braking with transmission downshifts for downhill driving. To prevent brake overheating engage the tow/haul mode any time extra braking is required. Higher engine speed and noise are normal in tow/haul mode. If you have to use the brakes for long periods of time you need to activate the tow/haul mode. On level roads turn off the tow/haul mode to improve driving comfort and fuel mileage.



Adjust your speed according to road and traffic conditions!

TROUBLESHOOTING		
Tow/Haul light on	Transmission set to towing mode	Push tow/haul button lever to turn off
Tow/Haul light blinking	Transmission malfunction	Stop as soon as possible in a safe place and call our Help Desk

CRUISE CONTROL

Cruise control operates above 35mph / 56km/h only

- To activate the cruise control, tap the ON button
- To set a desired speed press the SET+/ACCEL button and take the right foot off the accelerator
- To increase the speed, hold the SET+/ACCEL button until the desired speed is reached
- To reduce the speed, hold the SET-/COAST button until the desired speed is reached
- To get back to the last set speed after stepping on the brake, tap the RES button
- To cancel the current settings, tap the CAN button (if equipped)
- To turn off the cruise control, tap the OFF button

The cruise control disengages when the brakes are applied, but remains activated

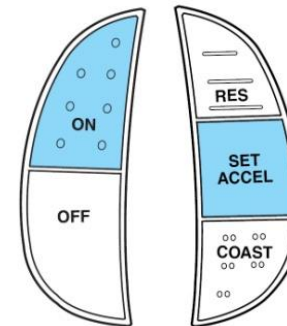

REAR VIEW MONITOR (Ford Transit)

Some Ford Transit vehicles are equipped with a rear view monitor in place of a rear view mirror.

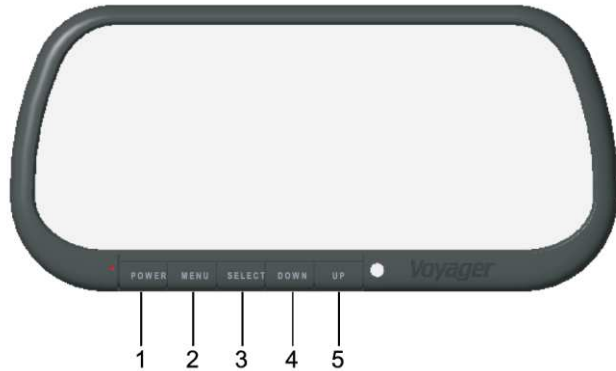

1. POWER - Press once to turn on; press again to turn off
2. MENU - Press once to turn to the On-Screen Display
- When in MENU returns to previous menu level
3. SELECT - To switch between input modes (cameras)
- When in MENU to choose highlighted function/option
4. DOWN (▼) - To adjust brightness, contrast, color, volume or sleep timer
- When in MENU to select options
5. UP (▲) - To adjust brightness, contrast, color, volume or sleep timer
- When in MENU to select options

Press SELECT to save any changes made.

FUSES AND RELAYS

Each vehicle has fuses and relays related to the operation of the vehicle – unrelated to the systems in the living (house) area.

FORD – E-Series (E350/E450) model:

1. Underneath the dash board (near parking brake):

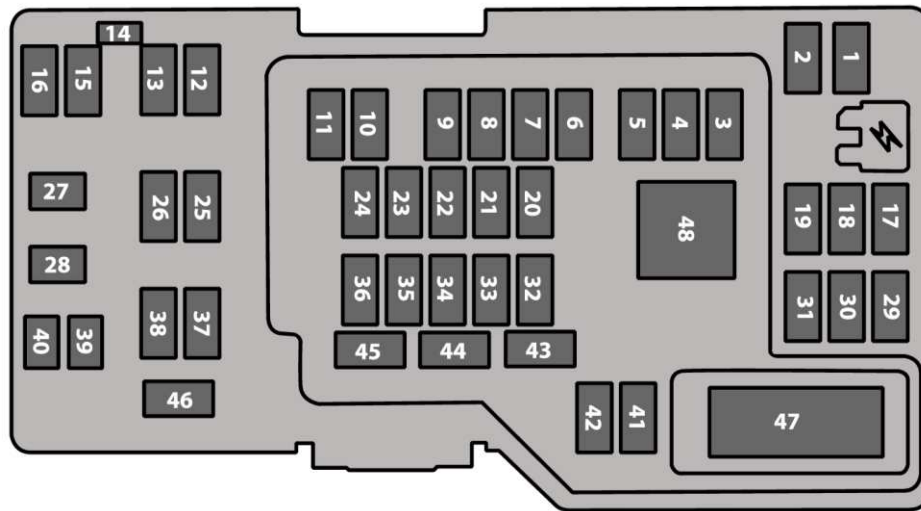

- | | |
|---------------------------|--------------------------------|
| 1. – 4. Spares | 26. Instrument cluster |
| 5. Brake interlock | 27. Ignition switch feed |
| 6. Turn & stop lights | 28. Audio mute |
| 7. Low beam – left | 29. Instrument cluster |
| 8. Low beam – right | 30. – 31. Not used |
| 9. Dome lights | 32. Restraint system |
| 10. Switch illumination | 33. – 34. Spare |
| 11. – 12. Not used | 35. Run/start |
| 13. Mirrors | 36. Anti-theft system |
| 14. – 16. Spares | 37. Air conditioner |
| 17. Door locks | 38. Not used |
| 18. – 19. Spares | 39. Radio |
| 20. Diagnostics connector | 40. Not used |
| 21. Spare | 41. Radio, switch illumination |
| 22. Parking lights | 42. – 44. Spare |
| 23. High beam | 45. Windshield washer |
| 24. Horn | 46. – 47. Spares |
| 25. Demand lighting | 48. Relay |

2. Engine compartment (driver side):

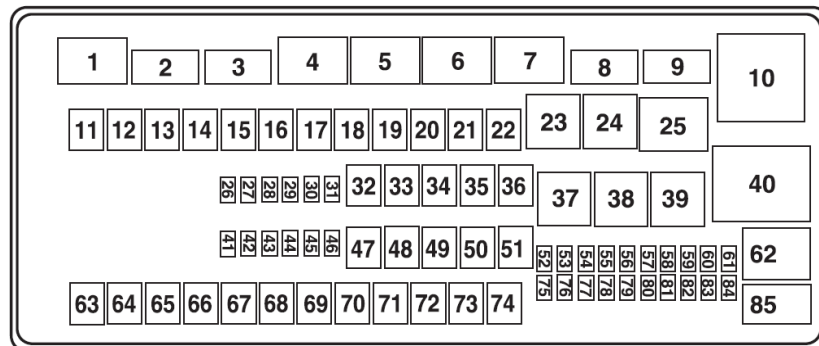

- | | | |
|------------------------|------------------------------|-----------------------------------|
| 1. – 10. Relays | 37. – 40. Relays | 65. Power point #2 (glove box) |
| 11. Empty/Spare | 41. – 42. Spares | 66. Power point #3 |
| 12. Run/Start* | 43. Fuel pump | 67. Power point #1 (dash board) |
| 13. Starter | 44. – 45. Spare | 68. Spare |
| 14. Run/Start | 46. PCM | 69. Not used |
| 15. Chassis battery | 47. ABS coil | 70. Spare |
| 16. – 22. Spare | 48. Trailer turn/stop lights | 71. Not used |
| 23. – 25. Relays | 49. Wiper motor | 72. Cigarette lighter/power point |
| 26. – 27. Empty | 50. – 51. Spare | 73. Not used |
| 28. Back up lights | 52. Run/start coil | 74. Power seats |
| 29. Compressor clutch | 53. ABS | 75. – 77. PCM |
| 30. Brake light switch | 54. Fuel pump | 78. Ignition coil |
| 31. Spare | 55. – 56. Not used | 79. Transmission |
| 32. Blower | 57. – 58. Trailer lights | 80. Spare |
| 33. ABS pump | 59. – 61. Not used | 81. – 82. Not used |
| 34. Spare | 62. Trailer battery | 83. Fuel pump diode |
| 35. PCM | 63. Spare | 84. Not used |
| 36. Ignition lock | 64. Not used | 85. Relay |

*) Battery solenoid for coach battery

FORD – Transit model:

Body Control Module

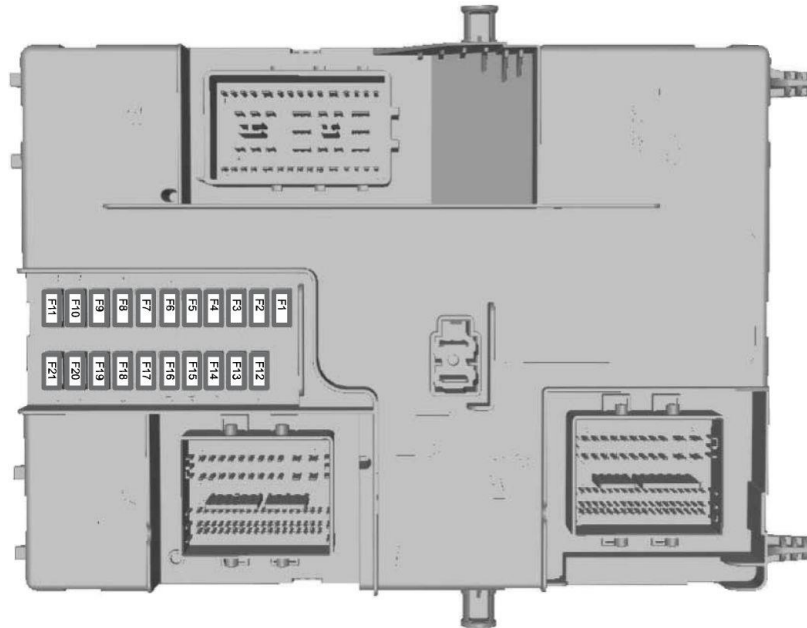
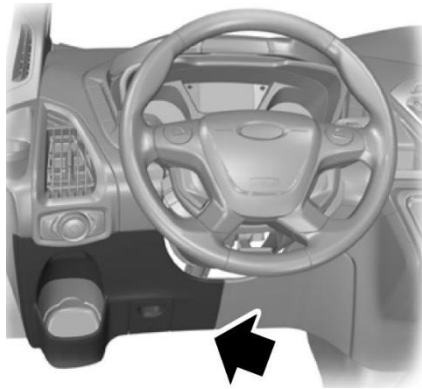

- | | |
|----------------------|------------------------------------------------------------|
| F1. Power locks | F13. OBD |
| F2. Power locks | F14. Turn signal |
| F3. Ignition switch | F15. Exterior lights |
| F4. Brake interlock | F16. Radio |
| F5. Not used | F17. Instrumentcluster |
| F6. Wiper washer | F18. Headlamp & steering wheel module & brake light switch |
| F7. Exterior mirror | F19. Control/Display module |
| F8. Not used | F20. Anti-theft |
| F9. RH Headlight | F21. Spare |
| F10. LH Headlight | |
| F11. Exterior lights | |
| F12. Not used | |

Passenger Compartment

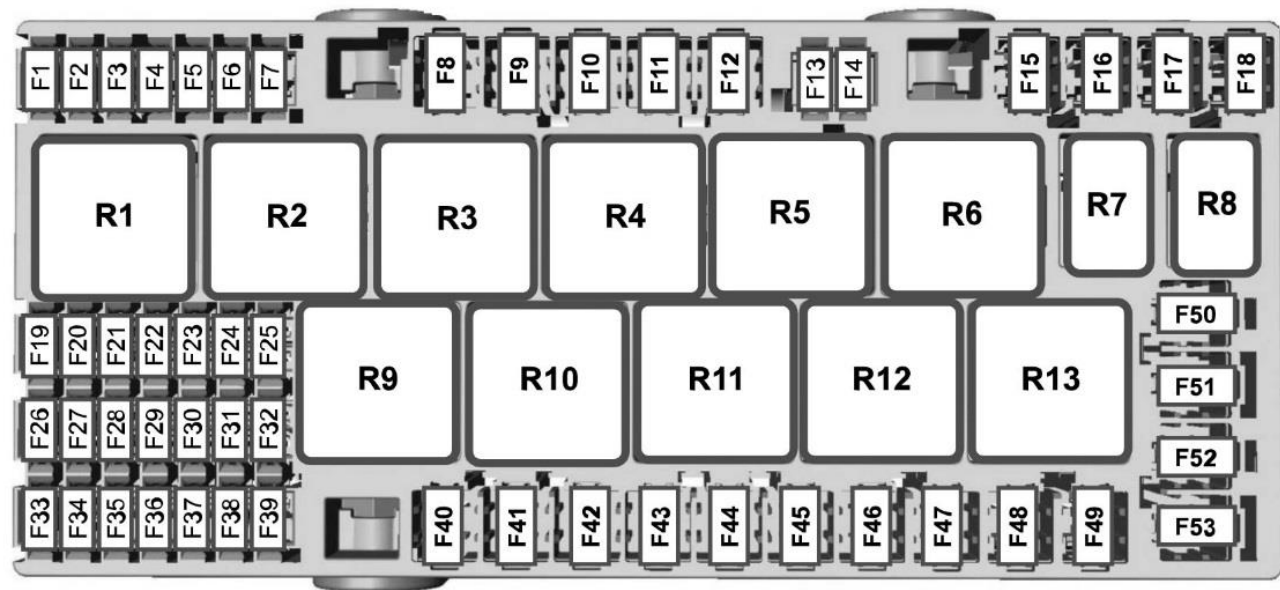

- | | | | | | |
|---------------------|---------------------|---------------------|---------------------------------------|------------------------|-------------------------|
| F1. Airbag | F10. Not used | F19. Trailer module | F28. Not used | F36. Horn | F45. Trailer |
| F2. ABS | F11. Not used | F20. Heated mirrors | F29. Not used | F37. Not used | F46. Power windows |
| F3. Interior lights | F12. Trailer lights | F21. Connectors | F30. Not used | F38. Blower/horn/wiper | F47. Cigarette lighter |
| F4. Trailer lights | F13. ABS | F22. Not used | F31. Trailer brake | F39. Keyless entry | F48. Rear power points |
| F5. Body connectors | F14. PCM | F23. A/C module | F32. Interior lights | F40. Blower motor | F49. Front power points |
| F6. Not used | F15. PCM relay | F24. Connectors | F33. Not used | F41. Not used | F50. Ignition relay |
| F7. Battery saver | F16. Body module | F25. Body module | F34. Not used | F42. Not used | F51. Not used |
| F8. AC power outlet | F17. ABS | F26. Heated mirrors | F35. Mirror switch & LH window switch | F43. Trailer | F52. Connectors |
| F9. Trailer brake | F18. Connectors | F27. Not used | | F44. Aux. power points | F53. Connectors |

Engine compartment

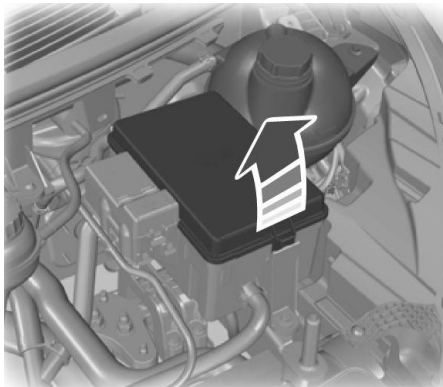

- | | |
|-------------------|---------------------|
| R1. Ignition | R10. A/C clutch |
| R2. Not used | R11. Diesel |
| R3. Not used | R12. Fuel inj. pump |
| R4. Not used | R13. Not used |
| R5. Not used | R14. Not used |
| R6. Wiper on/off | R15. Cooling fan |
| R7. Wiper speed | R16. Diesel |
| R8. Not used | R17. PCM |
| R9. Starter motor | R18. Cooling fan |

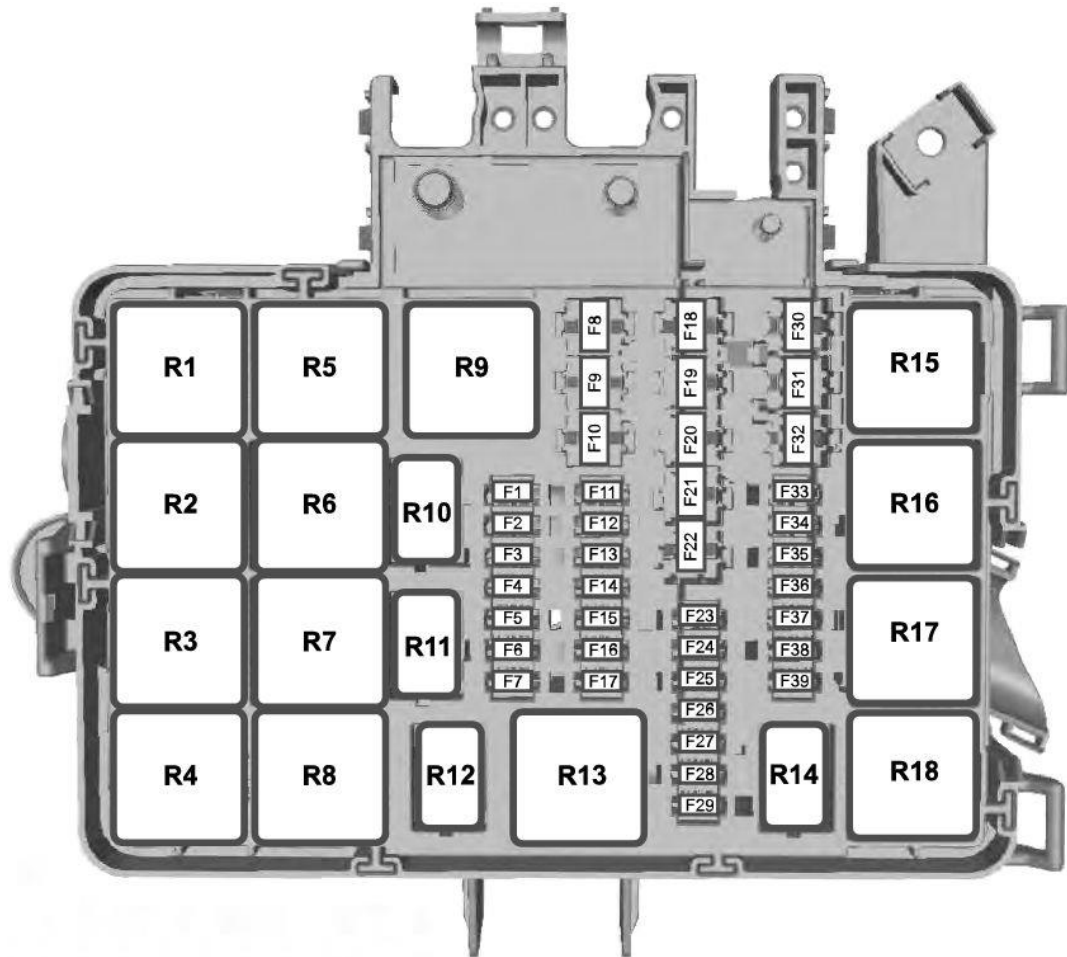

F1-F5 – Diesel	F12 – Diesel	F18 – Fuel pump	F28 – Crank case	F35 – PCM
F6 - Not used	F13 – Not used	F19 – Starter	F29 – PCV	F36 – Diesel
F7 – Transmission	F14 – Diesel	F20 – Diesel	F30 – Cooling fan 1	F37 – Fuel system
F8-F9 – Not used	F15 – Not used	F21 – Ignition	F31 – Not used	F38 – A/C clutch
F10 – Spare	F16 – Fuel pump	F22 – Diesel	F32 – Wiper motor	F39 – Emission systems
F11 – A/C clutch	F17 – Transmission	F23-F27 – Spares	F33 – F34 – Not used	

FORD – Bus style model:

A. Under dash board (near parking brake):

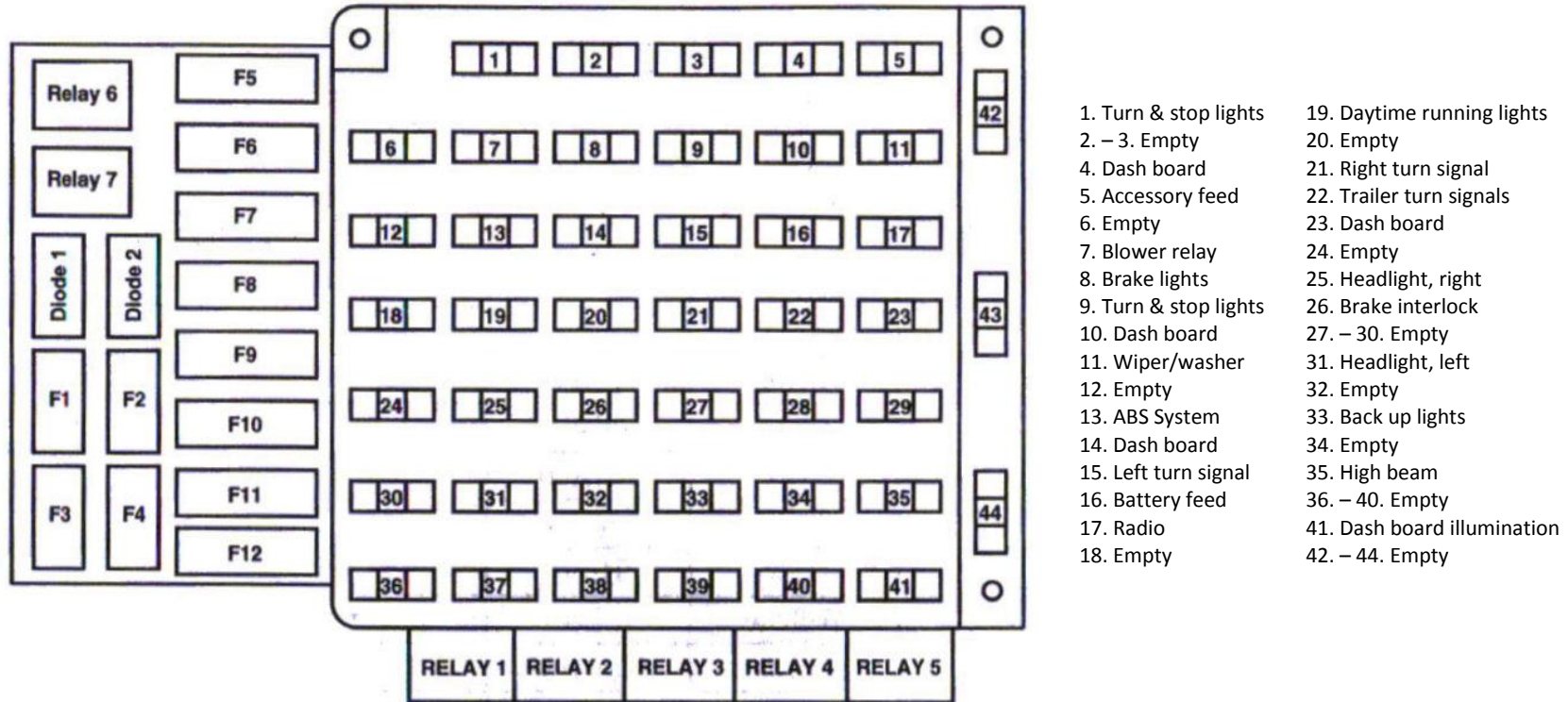

B. Below the dash board (near parking brake) or on top of dash board (underneath cover in behind the steering wheel):

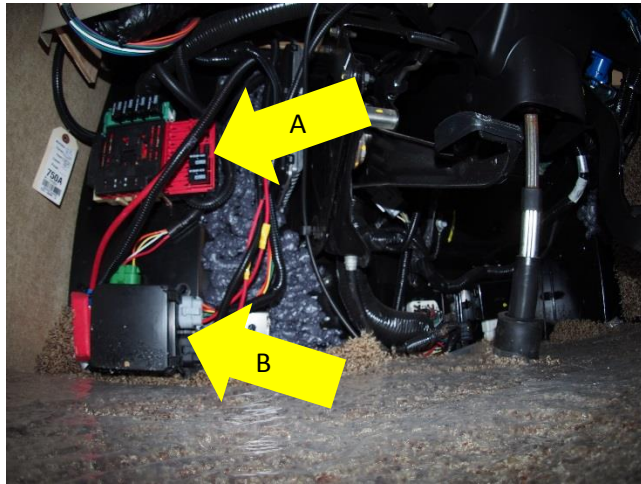

CB1-10A DRIVER SEAT	F4-5A STEP SWITCH	F8-15A DOCK LIGHTS	F15-10A MIRROR HEAT
F1-20A STEP MOTOR	F3-5A STEP IGNITION	F7-5A REAR VISION	F14-5A JACKS
	CB2-20A WIPER MOTOR	F6-5A WIPER	F13-5A MIRRORS
IGNITION ACCESSORY R2	IGNITION ACCESSORY R4	F12-10A DASH FAN	F11 SPARE
F2-15A FOG LAMPS	F5-30A CHARGE LINE	CB3-5A SHADES	F10 SPARE
FOG LAMP R1	IGNITION ACCESSORY R3	F9-25A HVAC BLOWER	

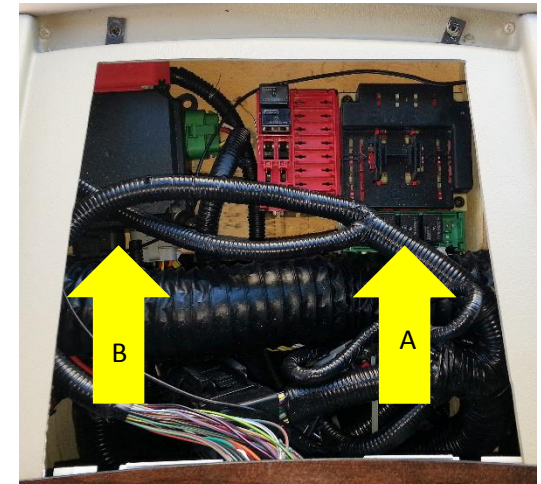

Engine compartment (center):

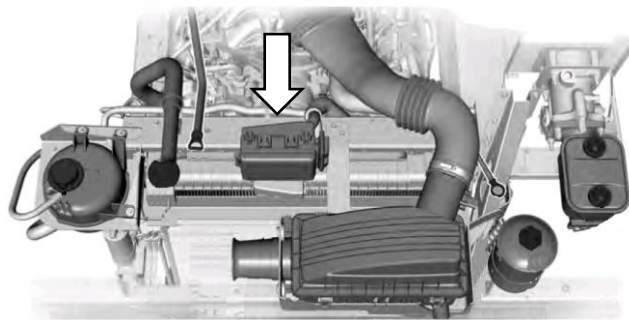

- | | |
|----------------------------|------------------------|
| 1. Power brake assist | 16. ABS system |
| 2. A/C clutch | 17. Horn |
| 3. Oxygen sensor | 18. A/C clutch |
| 4. PCM relay | 19. Brake switch |
| 5. PCM | 20. PCM relay |
| 6. Parking lights | 21. Fuel pump |
| 7. Ignition | 22. Cigarette lighter |
| 8. ABS | 23. Blower |
| 9. PCM | 24. Instrument panel |
| 10. Daytime running lights | 25. Ignition switch |
| 11. Fuel pump | 26. Ignition switch |
| 12. Instrument lights | 27. Head lamps |
| 13. Trailer brake | 28. Starter |
| 14. Lights | 29. Power brake assist |
| 15. Trailer lights | |

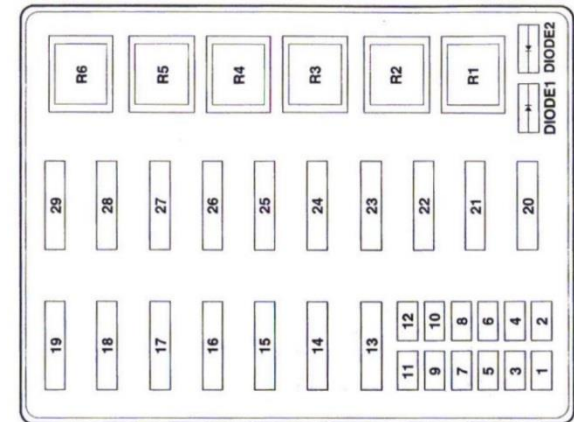

MOTORHOME EQUIPMENT

KEYS AND DOORS

There is only one set of keys for the motorhome. Splitting up keys may prevent you from locking yourself out of the vehicle – one person keeps the entry door keys and the driver keeps all others.

There are multiple keys for different locks:

- Entry door handle (round plastic head – Trimark; oval head – Bauer)
- Entry door dead bolt (rectangular head – Trimark; oval head, same key – Bauer)
- Some entry doors have one key for both locks (oval head – Bauer)
- Exterior compartment doors (round or square head; silver/grey – CH751 or G391)
- Some vehicles have a lock on for the exterior shower – use key CH751
- The bus style vehicles have a key for the engine compartment (large rectangular metal head – E3-5-15)
- The bus style vehicles have a key for the cab-over drop down bed (round head; silver – 0C01)

From the inside – move the handles to the lock (🔒) or unlock (🔓) positions. Aligned red dots = unlocked dead bolt.

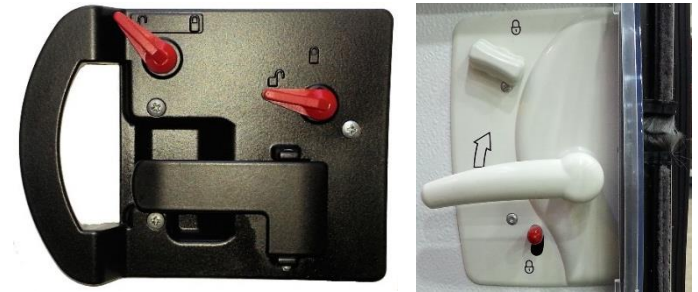

Please push on the doors while unlocking or unlatching.



To avoid injury or damage during high winds – Make sure the entry door is always hooked-in (if equipped) or closed at all times.

MONITOR PANEL

The monitor panel provides you with an overview of various systems:

- Fresh water tank level
- Holding/Black water tank level
- Grey water tank level
- Propane tank level
- Coach (house) battery charging / condition

The AUX button has no function on our vehicles

In addition, you can operate the water pump, water heater – on some models also operate the generator and the slide rooms.



TROUBLESHOOTER		
Monitor Panel is off	Battery disconnect switch off	Turn battery disconnect on
	Blown fuse	Replace fuse
Monitor panel shows holding tanks to be full or registers more than empty after dumping	Waste is stuck on the sensors	Fill tanks with about four buckets of clean water and some chemical. Driving should clean off the excess waste

COOK TOP

While using the cook top, turn on the hood exhaust above the cook top or the kitchen roof vent fan and open a window for fresh air and to prevent the smoke alarm from going off just because you cook. To turn on the propane at the burners, push in and turn the desired burner knob to the LITE position. To lite the propane, use the built-in lighter – either mechanical or electrical. Or use the supplied lighter or a match.



NEVER use the cook top while the vehicle is in motion! Do NOT use the cook top for comfort heating – danger of suffocation!

When cooking in a frying pan without non-stick lining use a small flame (low heat) only to prevent burning the food

TROUBLESHOOTER		
Cook top burner will not light	Out of propane or main valve closed	Fill propane tank or open main valve
	Electrical or mechanical lighter faulty	Use a match or manual lighter

OVEN (PROPANE)

While using the stove top and/or oven, turn on the hood exhaust fan or roof vent fan above the stove and open a window for fresh air and to prevent the smoke alarm from going off just because you cook. Push in, turn the oven knob to PILOT and HOLD it in for 30 – 60 seconds. While holding the knob in, use the open flame of a lighter or a match to light the pilot flame. Hold the lighter or match to the pilot (located next to the burner under the bottom rack of the oven) until the pilot flame lights up. Hold the knob for another 30 seconds – then adjust the oven control knob to the desired temperature.

Note: Be patient when lighting the pilot flame as it may take some time.

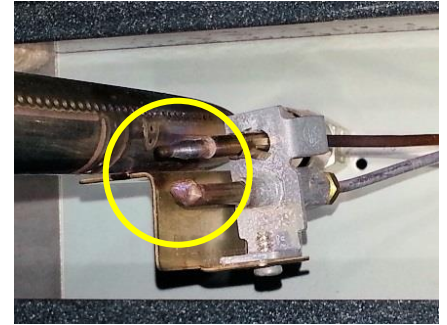

NEVER use the oven while the vehicle is in motion! Do NOT use the oven for comfort heating – danger of suffocation!

TROUBLESHOOTER

Turned knob but oven won't light	Pilot light must be lit manually	Turn oven knob to "Pilot" and keep pushed in, then use match or lighter to light pilot light
----------------------------------	----------------------------------	----------------------------------------------------------------------------------------------

KITCHEN COUNTER & DINING TABLE

Do NOT place hot pots and pans directly on the kitchen counters or dining tables. These surfaces are mostly plastic or covered by a plastic film and will melt/burn!



NEVER place a hot pot or pan on the counter top



ALWAYS use the trivet



ALWAYS use a cutting board when working with a knife

CAR RADIO

COACHMEN motorhomes car radios can only be played with the ignition key in the accessory or run (ignition ON) position. THOR motorhomes car radios run off the coach battery. Exterior speakers on THOR motorhomes play with the bedroom radio only.

Due to the variety of radios installed in the multitude of vehicles every different year, no descriptions can be made here. You can find details on the internet – search by name and model number.

On some models, iPhones & iPods cannot be played thru the USB connection. If the Bluetooth mode is asking for a code, try the generic codes 0000, 9999 or 1234.

CAB-OVER BED

Above the driver cabin there are different kinds of beds.

In the Class C motorhome it is a permanent structure with a removable section for easier access to the driver area. Just lift the removable section out of the way during the day.

In Class A motorhomes the bed is raised out of the way to allow driving of the vehicle. The bed is operated electrically.



1. Pull the front curtains closed
2. Remove the ignition key
3. Lower the bed electrically

When raising the bed, make sure nothing is left on the mattress.



ALWAYS use the safety net if small children are sleeping in the cab-over!



DINETTE BED

The dinette table can be converted to a bed as well. Some motorhomes have a sliding mechanism: 1) release the mechanism under the table; 2) push table down; 3) re-arrange the cushions.



Other models have actual table legs: 1) lift the table top off the legs; 2) remove the legs; 3) lay table between benches and re-arrange cushions.

Some models require installation of shorter legs to support the table top.

WINDOWS



Some motorhomes are equipped with flip windows – bottom section flips out. To prevent damages, such windows need to remain **CLOSED** while driving.

VENTILATION

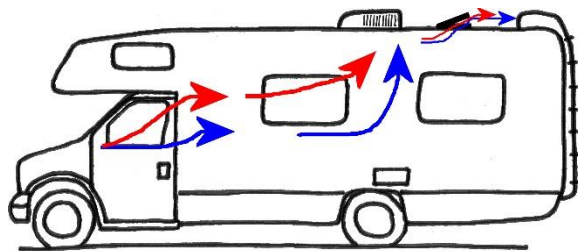

While driving, the windows should remain closed to reduce interior noise and negative air pressure. The bathroom roof vent can be opened two finger wide to assist the interior cooling or heating with the cockpit air conditioner/heater turned on. The aerodynamics will pull the air entering the vehicle at the dash board all the way thru the motorhome out the rear roof vent. This assists in getting cool/warm air thru the motorhome and removing any odors out of the vehicle.



FRESH WATER SYSTEM



Water tank fill

IMPORTANT:

Only use potable (drinking) water for city water hook-up and to fill the fresh water tank!



Pump switch

Tank filler & city water valve

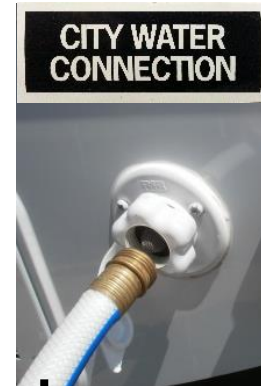

Water Pump



Water Heater

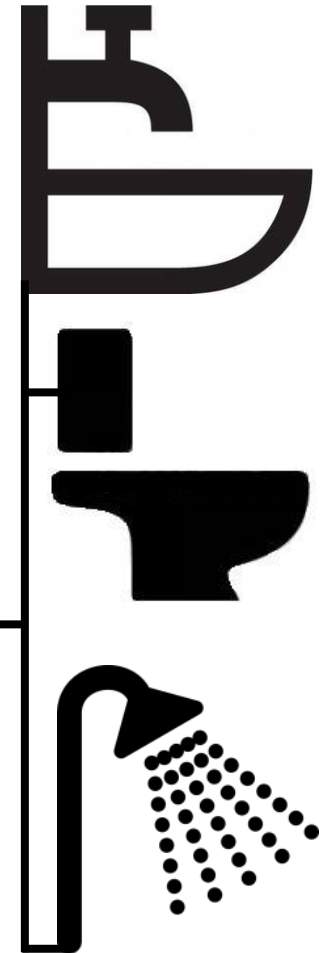
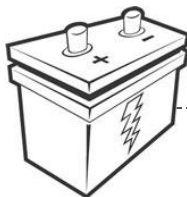

The fresh water tank overflows when it is full – either thru the fill opening or to the ground below the vehicle.

If you are staying at a campground with city water hook-up, there is no need for use of the water pump. The water pressure at some campgrounds can be higher than normal. It should not exceed 45 PSI (3.1 bar) – check with the campground manager. To prevent any leaks in the motorhome, use a pressure regulator or close the water faucet at the camp site ½-¾ way to reduce the water pressure – ask at campground office



TROUBLESHOOTER		
Fresh water tank will not fill	Tank is already full	Check for over flow or the monitor panel
	No water supply	Check water faucet at campground
	Not filling water	Make sure valve is in correct position – if applicable Connect to Tank Fill connector (Drinking glass icon)
Fresh water dripping under vehicle or pushing back out the fill hole	Tank is full and overflowing	Turn off water supply
	Drain valves open	Close drain valves
Pump fails to start when switch is on	Battery turned off	Turn on battery disconnect switch
	Blown fuse	Replace fuse in power center
	No water	Check water tank level
Water pump cannot be turned off	Water system hooked up to city water	Remove hose from city water
	Exterior switch is on	Turn off exterior switch

WATER HEATER

The water heater requires battery power to operate and heats with propane. Water does not heat with electricity! It takes 20-30 minutes to heat the 6 gallons/22 liters of water. The 'Pilot out' or DSI light will turn on briefly during ignition but turns off while the water is getting hot.

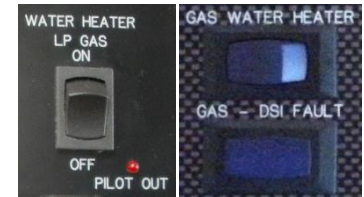

For safety reasons turn the water heater off while driving

TROUBLESHOOTER		
Water heater not working or illuminated switch not lit	No 12V power	Turn battery disconnect on Replace fuse
	Water is already hot	Check for hot water at faucet
DSI/Pilot light turning on	Temporary ignition failure	Turn off and wait 30 seconds before turning back on
	No propane or main valve closed	Fill propane tank or open main valve

SHOWER

Dry camping – make sure you have plenty of fresh water and the grey water tank is empty. Full hook-up – make sure the city water at the campsite is on and the grey water drain valves of the tank are open. The shower head has a water saving feature with an on/off valve built into the shower head to reduce the water consumption.



TROUBLESHOOTER		
No water at shower head	Valve at shower head is turned off	Open valve at shower head
	Lack of water	Turn on pump, check tank level or city water hookup
Water backs up into shower	Grey water tanks are full	Empty the grey water holding tanks

WINTERIZATION



Winterization of the motorhome's water system is required in below-freezing temperatures to prevent damages to the water pump, water tank, water lines, water filter, water heater and holding tanks. Damages to the plumbing system due to lack of winterization are the renter's liability.

Depending on the temperatures, the following steps are the responsibility of the customer.

Overnight - for a few hours - just a few degrees below freezing (32°F/0°C):

- Empty the waste water tanks before the temperature drops below freezing for the night. Frozen valves in the morning will prevent emptying the tanks. Defrosting solid ice will take more than just a few degrees above freezing in the morning
- Keep the water heater on overnight
- Turn the furnace on; set at minimum of 55°F (13°C) – even if you are not staying in the vehicle for the night!
It is strongly recommended to have electrical hook up as the furnace may drain the batteries in one night

All day below or around freezing; below freezing all night

If the day-time temperature remains below freezing or reaches barely above freezing, the water system has to be professionally winterized. This can only be done at a qualified RV service center or at a Road Bear RV branch and includes emptying the water tank, draining and bypassing the water heater and flushing the water system with a non-toxic antifreeze. Any cost associated with such a winterization (and de-winterization) is the renter's responsibility.

While a vehicle is fully winterized, the fresh water tank **CANNOT** be filled or the city-water be connected. Bottled water can be used to wash ones hands, face or brush ones teeth. Occasional rinsing of the drains with RV/Marine-approved antifreeze is required. When using the bathroom facilities of the motorhome, antifreeze needs to be used to flush.

Vehicles picked-up at the DEN, NYC & SEA locations are always winterized between October 31st and March 31st. Depending on weather conditions this period may be longer. Vehicles out of other rental locations may be winterized as well, depending on outside temperatures.

It is the renter's responsibility to have the vehicle winterized while on a trip at his/her own expense should the weather conditions require it. The renter is also responsible for having the vehicle re-winterized on the return trip if the vehicle was winterized at the time of pickup.

A \$100.00 winterization fee will be charged by Road Bear RV if the vehicle is returned non- winterized – regardless of the outside temperatures (exceptions only with prior authorization).

The renter will be fully responsible for any damages to the water system caused by freezing during their trip.

The state of Washington and certain surrounding states require the carrying of snow chains from November 1st until April 1st. Road Bear RV / BRITZ USA will provide 1 set of chains to fulfill the state requirement, but insurance regulations do not allow their use (NO coverage of undercarriage damage and driving in unsafe conditions).

Please contact the Help Desk for assistance and more information.

Waste Water System



The waste water system operates without any pump and empties thru a hose

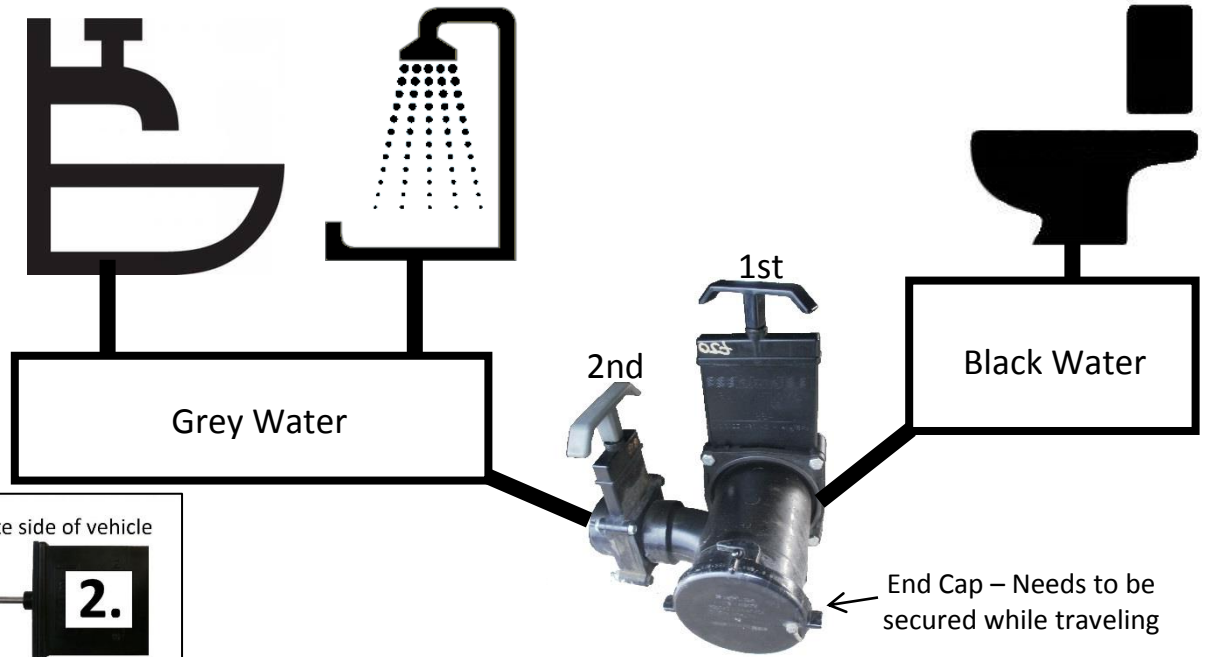

Some vehicle may have an extra valve on the passenger side

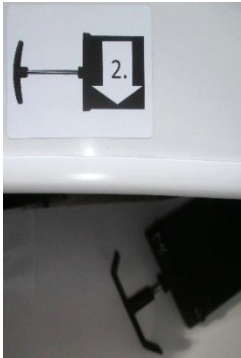

Drain BLACK water only when at least 2/3 full!

To drain the tanks:

1. Remove end cap
2. Attach sewer hose
3. Stick hose in ground
4. Open BLACK water* (large valve)
5. Close black water valve
6. Open GREY water valve**
7. Close grey water valve
8. Remove sewer hose
9. Install end cap
10. Rinse hose

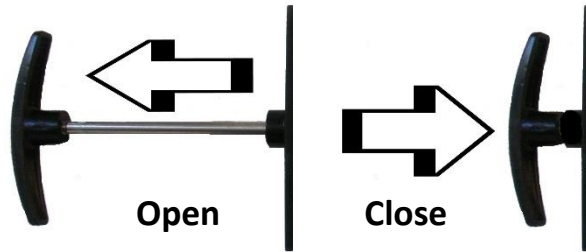

* Some vehicle have TWO black water valves! Open both valves to drain the tank

**21-23' vehicles (L- Model; Ford Transit) have two (2) GREY water valves – make sure to open both!

TROUBLESHOOTER		
Waste tank will not drain	Valve(s) closed	Ensure all valves are open – see opposite side of vehicle
	Waste tank empty	Check for water in tank thru toilet (on some models)
	Drain pipe plugged	Insert a wire to unclog from the outside – CAUTION: sudden discharge
	Contents in tank are frozen	Dump in warmer climate
	Waste water valve is broken	Visit a repair facility – see page 22
Grey water is backing up into shower	Full waste tanks	Empty the grey water holding tanks
Monitor panel shows full or registers more than empty after dumping	Waste is stuck on the sensors	Fill tanks with about four buckets of clean water and some chemical. Driving should clean off the excess waste

TOILET

All motorhomes are equipped with a flush toilet. Flushing the toilet requires water pressure from the water pump or city water connection. Before using the toilet ensure you have water pressure!

Using too much toilet paper and not flushing enough can clog some of the toilets.

Flushing the toilet is done with a foot pedal. Flush for at least 10 seconds.



To prevent odors and to dissolve human waste add **RV holding tank chemicals** after every first time use on an empty tank. Do NOT use regular household toilet cleaner!

Treating Your RV Toilet

YouTube
Learn how to properly and easily treat your RV toilet.

View The Video Here
www.uniquecampingmarine.com/pages/road-bear

unique + ROAD BEAR



Do NOT drop anything in the toilet that does not belong!



ELECTRICAL SYSTEM

12 VOLTS – BATTERY POWER

The coach (house) battery operates many electrical appliances. Make sure the battery disconnect switch is always turned ON (USE).



If you are dry (freedom) camping (without electricity from the campground) for a few days and do not drive much, you have to run the engine at least two hours per day to maintain enough battery power. If the outside temperature is low and you use the furnace (heater) at night, you have to run the engine at least four hours per day to maintain enough battery power. A fully discharged battery requires driving (or running of engine) for at least eight hours. Battery life varies widely depending on different factors.

The coach battery is getting charged while driving and when connected to the campground or when the generator is running. The battery condition can be seen on the monitor panel with the BATT button.

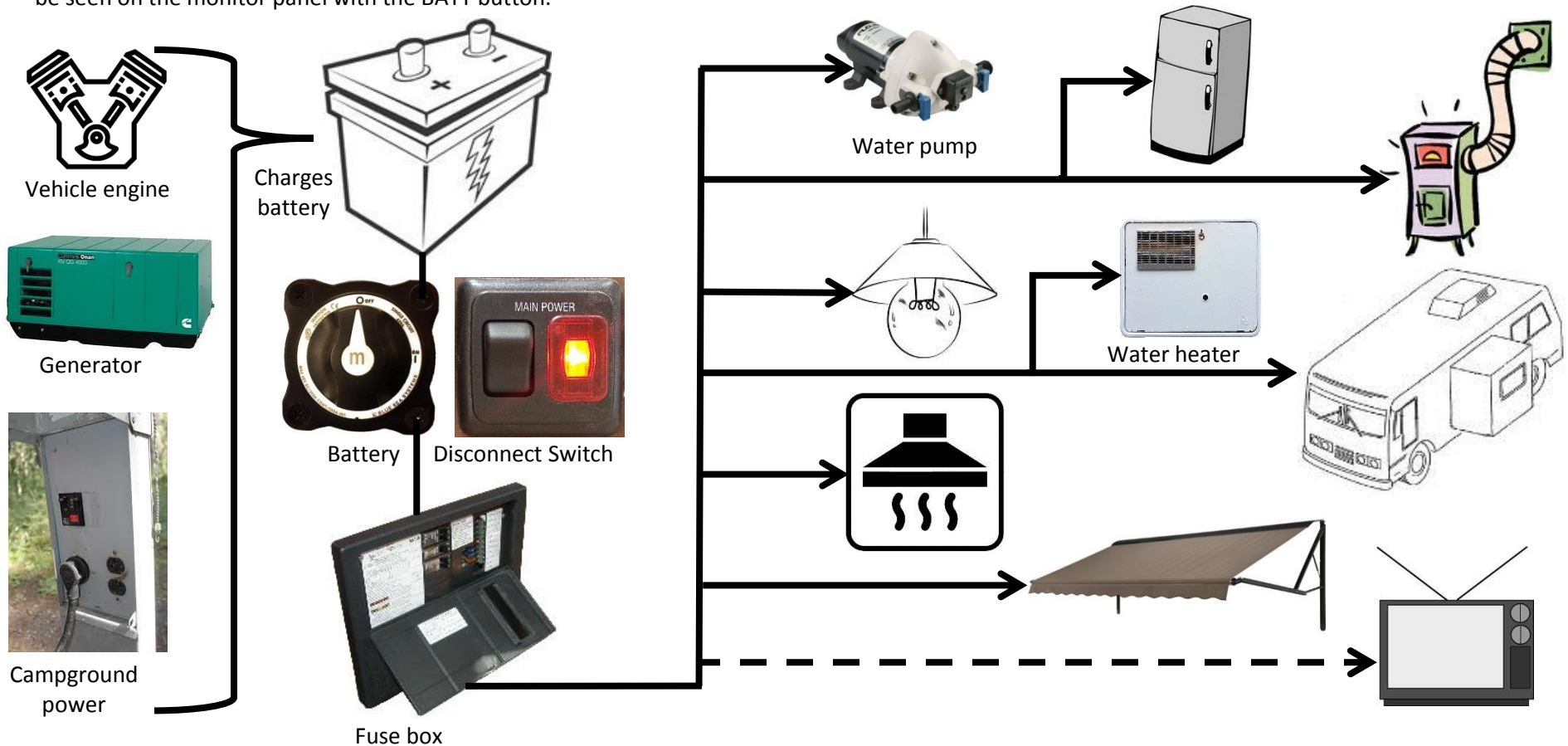

BATTERY DISCONNECT SWITCH



All motorhomes have a coach battery disconnect switch which is located by the entry door. Leave the switch ON (USE) to assure overall function of the appliances. If the switch is OFF (STORE) – nothing in the motorhome will work and the coach battery will not get charged when connected to campground electricity or running generator.



The only time it has to be turned OFF is when re-filling fuel or propane

FUSES



Each motorhome has a fuse box which is located in the bedroom or living area. It contains a series standard 12 volt automotive fuses. If any electrical appliance stops to operate, check the fuses first. A defective fuse has the thin wire inside broken. Also a red LED in the fuse box lights up.



Good

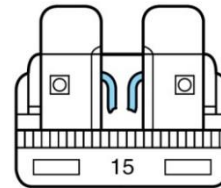

Bad

Red light = bad fuse

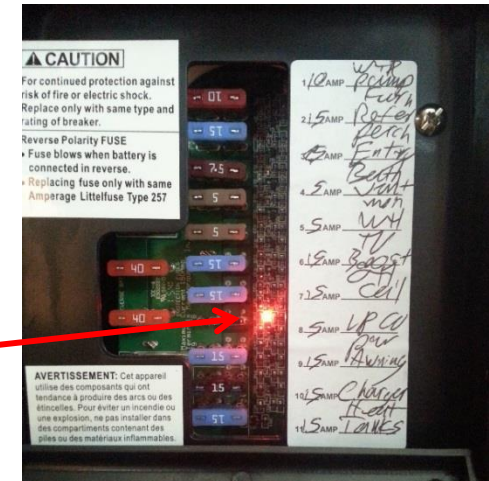

TROUBLESHOOTER		
No power at all	Battery disconnect switch off	Turn battery disconnect switch back on
Battery level low on the monitor panel	Battery voltage is low	Recharge the battery by starting engine or connecting at campground
Battery not charging while driving	Blown fuse	Call the Help Desk for assistance
Battery not charging with campground electricity	Tripped circuit breaker	Reset all circuit breakers in the fuse box
	Technical problem	Call the Help Desk for assistance
Lights don't turn on	Switch at wall or on lamp off	Turn both switches on
	Battery disconnect switch off	Turn battery disconnect switch on
Lights dim or half bright	Battery voltage is low	Recharge the battery by starting engine or connecting to campground

120 VOLTS – HOUSEHOLD POWER (max. 30 Amperes)



For proper operation 110-128 Volts are required.

Switch main power on **after** connecting power cord



Push & Twist to connect



Fuse box



30 Amperes campground power



Generator Power

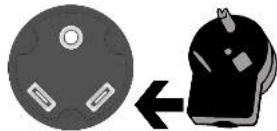

Vehicles with a detachable power cable or no power outlet automatically select between generator and campground power

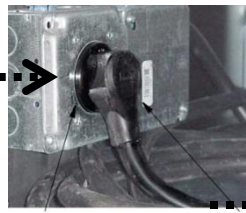

Generator Receptacle Power Cord

Generator power

Some vehicles have a power outlet for the fixed cable and it always needs to be connected to have generator power

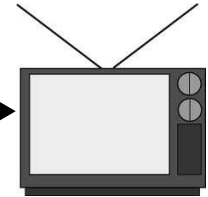
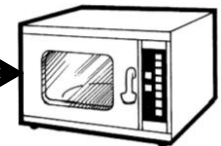
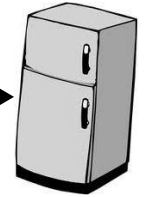

GFI – see next page

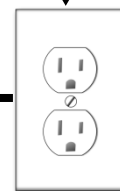
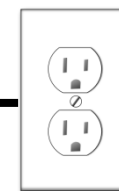
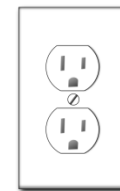

CIRCUIT BREAKERS

Every motorhome has a fuse box which is located in the bedroom or living area. It contains a series of 120 volt circuit breakers. If any electrical appliance stops to operate, check the circuit breakers first.



- A circuit breaker ON
- B circuit breaker TRIPPED (activated)
- C circuit breaker OFF



1. Move breaker to OFF
2. Move breaker to ON

Turning the circuit breaker directly back ON will keep the electricity interrupted.

GROUND FAULT INTERRUPTER (GFI/GFCI)

The GFI (Ground Fault Interrupter) is a special circuit breaker for 120 volt wall outlets. It is part of an electrical outlet – usually in the bathroom. To reset, first unplug all devices and push the RESET button back in. It will only reset if you have 120 volt power from the campground or generator.



Push to Reset circuit after ground fault tripping.

Push to Test. Should break circuit. Press Reset button to reconnect.

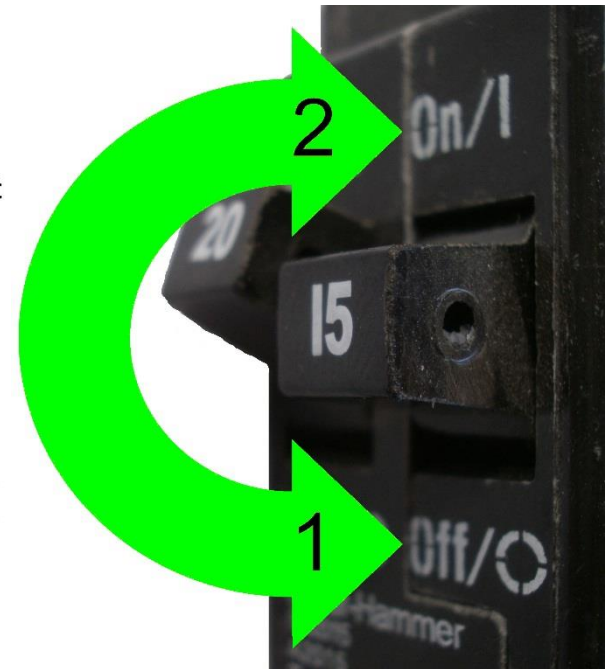

OVERLOADING THE CIRCUIT

Using more than one appliance at the same time will overload the circuit and interrupt the power. Turn off the air conditioner before using the microwave, toaster or hair dryer, etc.

The campground provides 3600 watts (120 volts @ 30 amperes) - Typical power usages:

Air Conditioner	1200-2400 watts	10-20 amperes (30+ peak)	Microwave	900 watts	7.5 amperes
Coffee maker	900 watts	7.5 amperes	Toaster	900 watts	7.5 amperes
Laptop charger	300 watts	3 amperes	Battery charger	720 – 3360 watts	6-28 amperes

For proper operation of all electrical equipment the correct voltage supply is required. Too low voltage of 110 or less and excessive high voltage of over 128 Volts can cause improper function or even damage the equipment. Change to a different power supply on the campground or run the generator if you notice improper function of the electrical equipment.

TROUBLESHOOTER		
No electrical power	No power source	Connect to campground or start generator
	Campground power off	Check breaker/main switch at campground
	Power cable unplugged	Plug in cable into junction box for generator or to campground
	Circuit breaker may be off or tripped	Reset breaker(s)
	Bad power cord adapter	Replace adapter
No power at receptacles (outlets)	No power source	Make sure you have power from the campground or generator
	GFI receptacle may be off or tripped	Reset GFI (only possible with 120V power to vehicle)
	Circuit breaker may be off or tripped	Reset breaker in fuse box
Incorrect operation of equipment	Voltage too low or too high	Change power source on campground or use generator

GENERATOR



The generator uses gasoline from the vehicle fuel tank. A minimum of $\frac{1}{4}$ fuel tank is needed in order to operate. Fuel use up to 0.7 gallon / 2.7 liter per hour. Using two appliances at the same time can overload the generator itself and shut it down. Turn off every appliance before re-starting the generator.

NEVER run the generator for more than one minute with the green service door removed! Overheating and serious mechanical damage could occur!

Higher temperatures & altitudes will reduce power output and can cause the generator to stop running. Temperatures above 100°F/38°C can cause fuel vapor-lock and stop the generator from running (3.5% decrease for every 1000ft/300m in elevation and 1% decrease for every 10°F/5.5°C above 77°F/25°C).

The generator produces 3600 watts (4000 peak) 120 volts @ 30 amperes - Typical power usages:

Air Conditioner	1200-2400 watts	10-20 amperes (30+ peak)	Microwave	900 watts	7.5 amperes
Coffee maker	900 watts	7.5 amperes	Toaster	900 watts	7.5 amperes
Laptop charger	300 watts	3 amperes	Battery charger	720 – 3360 watts	6-28 amperes



Circuit Breaker on Generator

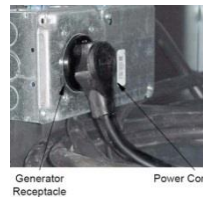

Generator Receptacle
Power Cord

Generator Power

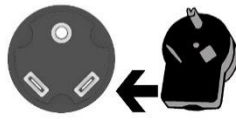

Power Cord connected*



Fuse box with Circuit Breakers

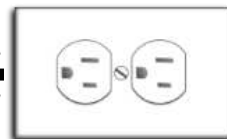
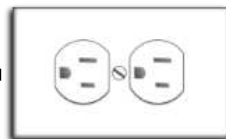
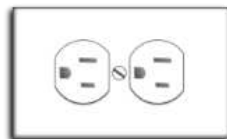
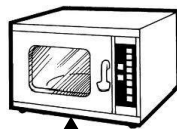
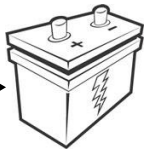

GFI – see page 46

*Vehicles with a removable power cord or no outlet to connect the cable into will automatically select between generator and campground power

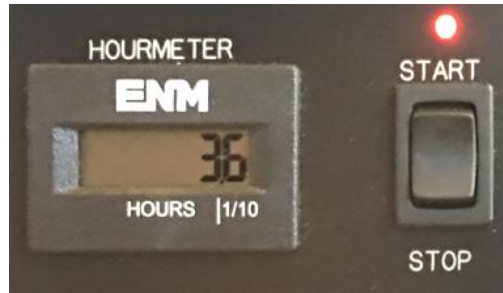

The generator motor oil level needs to be inspected and adjusted every eight (8) hours of use.

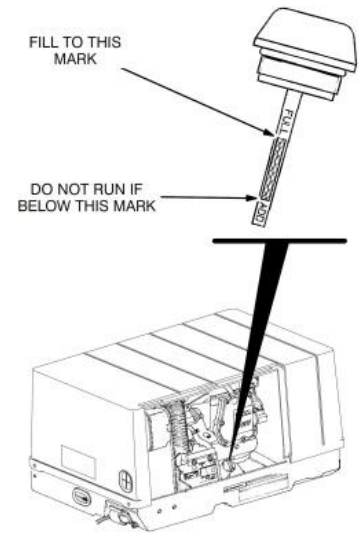

Higher temperatures & altitudes will reduce power output and can cause the generator to stop running. Temperatures above 100°F/38°C can cause fuel vapor-lock and stop the generator from running (3.5% decrease for every 1000ft/300m in elevation and 1% decrease for every 10°F/5.5°C above 77°F/25°C.

TROUBLESHOOTER		
Generator does not crank	No battery power	Start engine and run for 15 minutes before starting generator
		Class A (U- models) check circuit breakers next to coach batteries
Generator cranks but will not start	Generator may be out of fuel	Press 'Prime' or 'Stop' button for 15 seconds and try again
	Fuel vapor-lock (not liquid anymore)	Check the fuel level - At least ¼ of fuel in vehicle tank required
Generator runs but no power	Circuit breakers may be off or tripped	It is too hot – wait for cooler temperatures
	Power cord unplugged	Reset breaker at generator and/or in fuse box
Circuit breaker trips	Overloaded circuit	Plug power cord into receptacle – if equipped
Generator stalls	Overloaded	Turn off all the electrical loads and reset the circuit breaker
Generator stalls	Overloaded	Turn off all the electrical loads and wait 3 minutes before restarting
Stops while driving (corners)	Low on fuel	Turn off all the electrical loads and wait 3 minutes before restarting
		Refill fuel tank – more than ½ full is recommended

REFRIGERATOR



The refrigerator is using propane or household (120 volt) power to cool but needs battery power (12 volt) to operate. For an extended stay it is recommended to have electricity from the campground. The motorhome refrigerator is technical different from a household refrigerator and therefore less efficient by design.

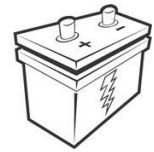
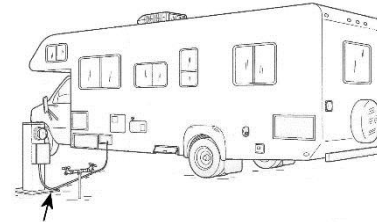

For proper operation, the vehicle needs to be on level ground. Use the drive-up levelers as needed.

Leveling:

CAUTION: The refrigerator is made to operate within 3° off level side-to-side and 6° off level front-to-back (as looking at the front of the refrigerator). Operating it at more than these limits can cause damage to the cooling system and create a risk of personal injury or property damage. Make sure the vehicle is level before you operate the refrigerator.

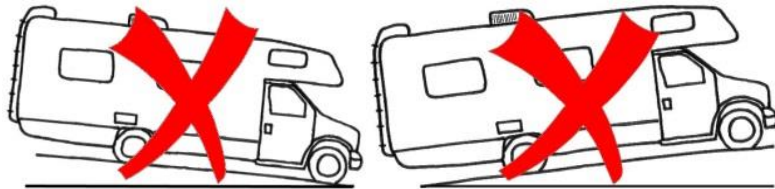

The DOMETIC model has an adjustable temperature sensor. Make sure the sensor cable is not hanging loose.



For the most efficient operation pre-cool all food at home; do not place any hot or warm food in the refrigerator and do not overfill it, blocking air circulation.

If possible, keep the refrigerator side of the motorhome in the shade.



Refrigerators work best with outside temperatures between 32-75°F (0-25°C) and below 5500 feet (1675 meter) elevation

Operation

DOMETIC

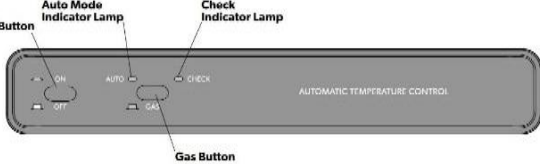

Push ON/OFF Button to turn ON the refrigerator
 Set GAS Button to Auto mode (pushed in)
 AUTO Mode Indicator Lamp needs to be on
 Check Indicator Lamp indicates propane ignition problem – turn the fridge OFF and check the gas supply and turn back ON

NORCOLD

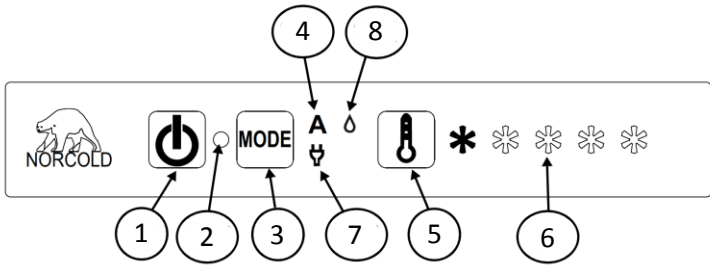

Press button (1) to turn on – green LED (2) on; Select AUTO mode (3); (4) lights up; Select temperature (5, 6); (7) = electrical operation; (8) = propane operation
 A red light (2) indicates a problem – turn the fridge OFF, wait one minute and turn back ON

Refrigerators work best with outside temperatures between 32-75°F (0-25°C) and below 5500 feet (1675 meter) elevation. At higher altitudes the propane operation may not properly ignite and cool less or not at all. At higher temperatures, the cooling will be less efficient. At ambient temperatures below freezing the fridge can fail. Extended exposure to freezing temperatures the fridge could get damaged.

TROUBLESHOOTER		
CHECK or RED light on	Temporary malfunction	Turn off and wait about 45 seconds before turning it back on
	Out of propane or main valve closed	Fill propane tank or open main valve
	Ignitor problem	Elevation – Air/gas mixture unable to ignite – travel to lower altitude Visit a repair facility – see page 22
Refrigerator is off	Fridge turned off	Turn it on
	No or low 12V power	Turn battery disconnect on / recharge battery
	Fuse blown	Check and replace fuse
	Thermal fuse tripped	Reset thermal fuse on back of refrigerator (outside)
Reduced cooling	Outside extremely hot	Move out of sunshine
	Temperature sensor not properly adjusted or hanging loose	Adjust temperature sensor (Dometic only)
	Motorhome not level	Level out motorhome
Refrigerator not cooling	Any of the above	All of the above
	Motorhome not level	Level out motorhome and turn off refrigerator. Requires complete shut down for 24 hours. Vibrations while driving may restore system but problem may persist and will require a larger repair.

AIR CONDITIONER



The roof air conditioner requires 120 volt power from the campground or the generator to operate but also battery power for the controls. See pages 43 & 45

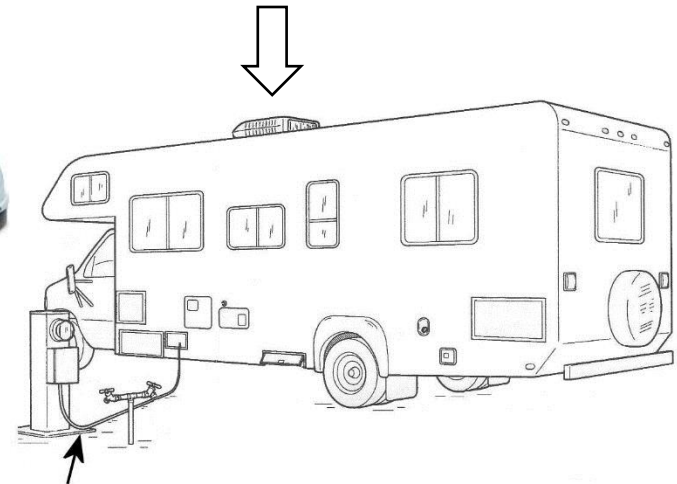

A/C do **NOT** provide any heat – such options are not installed.

Wall thermostats:

These systems have air channels in the ceiling and multiple vent openings. To quickly cool the vehicle, close the ceiling vents and open the main vent at the air return/filter. After cooling the main area, open the smaller ceiling vents and close the main vent.

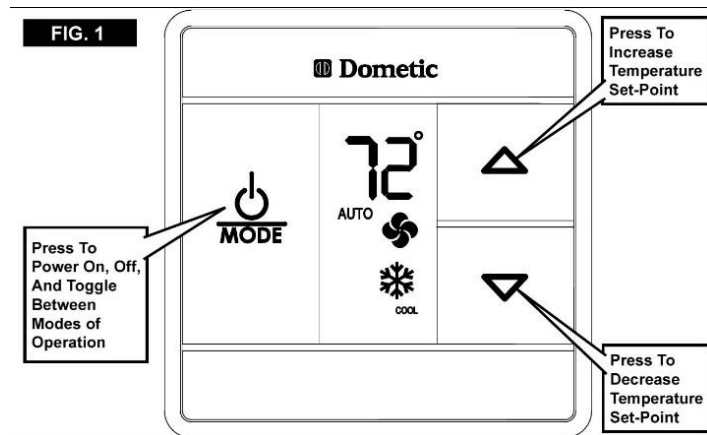

1. Press (MODE) once
 2. Fan – Select Au (auto)* (press Δ & ∇ to change selection)
 3. Press MODE again
 4. Select temperature
- To turn OFF - press MODE again 2x
To change between Fahrenheit & Celsius press the Δ & ∇ buttons at the same time

1. System – Select COOL
 2. Fan – Select Auto Low
 3. Select temperature
- To turn OFF – Select System OFF

*In Hi or Lo the fan will work without cooling

Ceiling mounted controls:

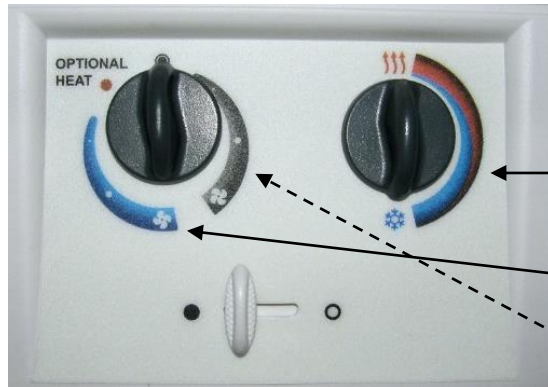

- 1. Cooling – Turn system knob to COOL (blue) – NO heat (red)
- 2. Select temperature (blue)
- Fan only (grey) – NO cooling

- 1. Cooling – Turn system knob to COOL
- 2. Select temperature (blue)



A/C cools to a **MAXIMUM of 20°F/11°C** below ambient (exterior) temperature
 Klimaanlage kühlt **MAXIMUM 11°C** unter Aussentemperatur

With inside temperatures of 100°F/38°C or higher it can take hours to cool to a comfortable temperature. Opening windows and doors will prolong the cooling time.

To avoid tripping the circuit breaker or stalling the generator, wait 3 minutes before turning the A/C on again.

TROUBLESHOOTER		
A/C does not run	No power source	Make sure you have power from the campground or generator
	Circuit breakers may be off or tripped	Reset circuit breakers at campground, fuse box and/or generator
A/C not or weak cooling	Evaporator coils are iced up	Turn A/C off and run fan only for about 1 hour
Blower runs but no cooling	Blower on but not the A/C	Set fan to AUTO and switch to COOL

FURNACE (HEATER)



The furnace (heater) is using propane and requires battery power. For a stay longer than one night it is strongly recommended to have electricity from the campground

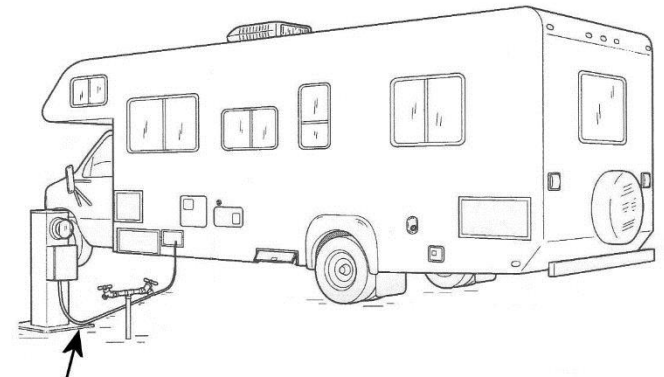
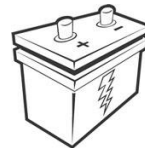

During any extended stay without campground power supply, the furnace will drain the battery in just one night at low temperatures. See page 43 (12 Volts Battery Power)

To operate the furnace, ensure to have enough propane and campground power or a fully charged battery

A built-in time delay turns on the blower first before heating. It also keeps the fan run longer than there is actual warm air blowing.

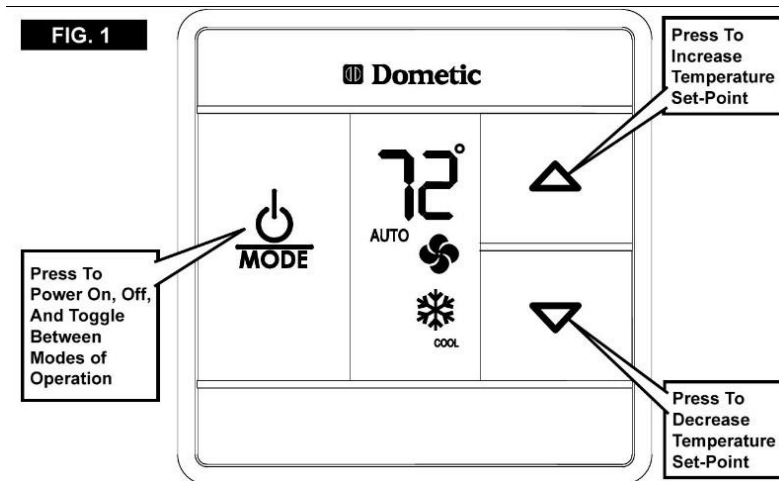

To change between Fahrenheit & Celsius press the Δ & ∇ buttons at the same time.

Fan: Set to AUTO - in Hi or Lo the fan of the air conditioner will blow unrelated to heating



1. System – Select HEAT
 2. Fan – Select Auto Low
 3. Select temperature
- To turn OFF – Select System OFF



- Move top lever to ON (may go hard)
- Adjust temperature at bottom

OFF ← → Temperature setting



TROUBLESHOOTER		
Furnace blows only cold air	Out of propane or main valve closed	Fill propane tank or open main valve
	Too cold outside - Propane cannot vaporize	Travel to warmer weather or use electrical space heater
	Possible technical defect	Buy and use electrical space heater
Ask for assistance on campground or call the Help Desk		
Furnace does not run at all	No 12V power	Turn battery disconnect on or replace fuse in fuse box
		Reset switch behind exterior access door (plastic with exhaust)
	Low battery power	Start engine to charge battery – see page 43 (12 Volts Battery Power)

TV & DVD PLAYER

TVS THAT COULD DISTRACT THE DRIVER WILL NOT OPERATE WHILE VEHICLE IS IN MOTION!

Furrion TVs require 120 volts from the campground or generator to operate



In some Leprechaun vehicles there is a separate power switch for the TV & DVD.

Some DVD players light up and show the clock or mode when power is present.

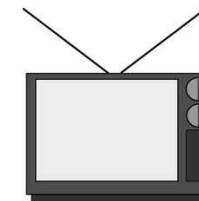

TVs have a power light on the front:

JENSEN: A blue LED indicates there is power to the TV. When the TV is turned on, the LED turns off (black).

FURRION: A red LED indicates there is power to the TV. When the TV is turned on, the LED turns green.

1. Connect the optional TV cable (if service available) to motorhome & campsite.
2. **AMPLIFIER** – For cable reception turn it OFF / for antenna reception turn it ON. The amplifier is usually built into the TV cable outlet. In some vehicles it could be separate, located inside of or on the outside of an overhead cabinet.
3. Set the input source to TV [press source/input button on TV or remote].
4. Select AIR or CABLE in the CHANNEL menu and run an AUTO SCAN to receive the locally available channels. Repeat this step at every new campground.

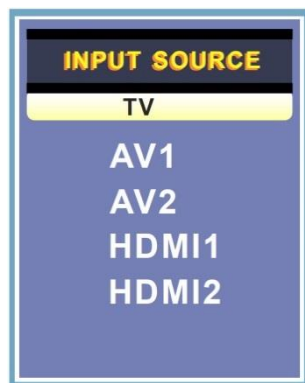

TV – Antenna or cable
AV1 – DVD player

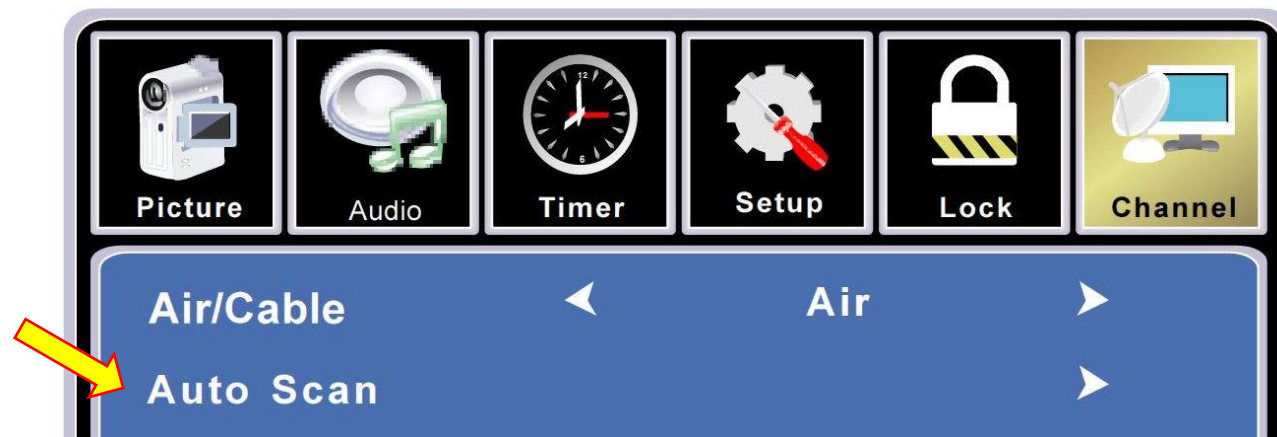

DVDs need to be designed for Region 1 (USA & Canada) to properly work. If you brought DVDs from another country, they may not play.



TROUBLESHOOTER		
TV does not turn on	No campground / generator power	Plug into campground / start generator
	TV power switch off	Turn TV switch on (usually near DVD player)
	Power plug in cab-over not fully plugged in	Check connector and plug in properly
	Circuit breakers may be off or tripped (120 volts)	Reset circuit breakers
	Fuse blown* (12 volts)	Replace fuse*
	Ignition interlock activated	
Remove ignition key from lock		
No picture / reception	Input source incorrect	Change input source as required
Poor/no cable TV reception	Antenna amplifier turned ON	Turn amplifier switch OFF & do channel search (auto scan)
Poor antenna reception	Antenna amplifier turned OFF	Turn amplifier switch ON & do channel search (auto scan)
DVD not playing	TV not set to AV	Change input source on TV to AV
	Incorrect region	There is nothing one can do
	Cables not connected	Check audio/video cables at TV and DVD player
	Technical glitch	Press reset button and try again (Jensen models only)

*Possibly labeled as Appliances/Entertainment. Some TVs have also an in-line fuse in the power cable to the TV; in addition to a fuse in the fuse box.

SLIDE ROOM (SLIDE-OUT)

The slide room (if equipped) is a great feature that allows you to greatly expand your living space while parked.

Please follow these instructions before operating the slide room to assure proper function:

1. Make sure the motor home is level



2. The parking brake has to be engaged



3. Make sure the transmission is in the 'P' (park) position



4. Turn the engine off and remove the ignition key or the slide room will not operate



5. Make sure the driver seat backrest is moved forward so that it does not interfere with the motion of the slide room. Damages to the driver seat and slide room trim are the responsibility of the renter

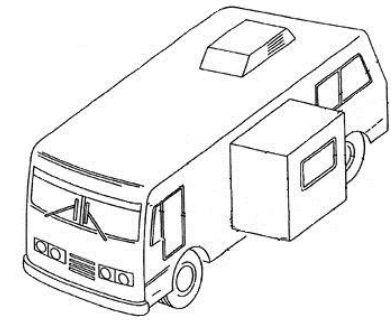

6. Verify clearance to objects on the outside before operating the slide room to its full extension (min. 3.3 ft. / 100 cm outside clearance)

7. Make certain that no objects get jammed between the slide room frame and the sidewall while extending the slide room. **NEVER store anything on top or on the sides of the slide room**

8. Do not allow anyone to sit on the slide room sofa, bed and/or dinette while operating the slide room

9. Push the button to extend the slide room until the slide room stops completely **and the motors turn off automatically** – hold button for 3 more seconds

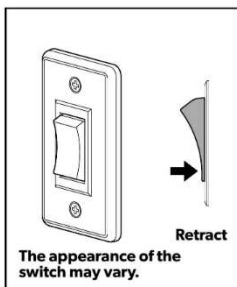

To retract the slide room, repeat the steps 5 – 9.

Make sure the path is clear of objects and watch your feet while retracting

NEVER drive the motor home while a slide room is extended



Move seat forward before operating slide room

Move seat & backrest forward while driving to avoid damage to the driver seat.

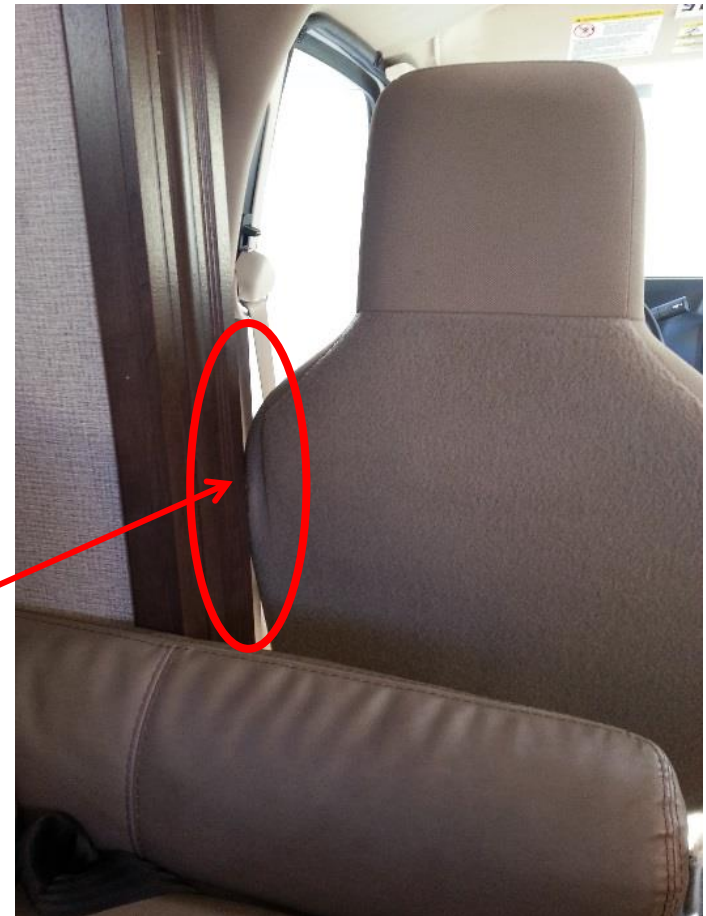

TROUBLESHOOTER			
Slide room does not move	Safety inter-lock engaged	Apply parking brake and remove key from ignition	
	No power supply	Turn on battery disconnect	
	Weak battery	Run engine for 15 min. – start generator – turn off engine	
		Connect to campground electricity	
	Fuse blown	Replace fuse – call Help Desk for location	
Slide room only moves on one side	Possible mechanical/electrical defect	Retract as much as possible to be able to drive – call Help Desk	

AWNING – Manual Operation



Before rolling out the awning, ensure there is enough space to fully extend it and that it does not interfere with tree branches, etc.



NEVER roll out the awning in windy conditions or rainy weather!

NEVER leave the awning unattended (absence or overnight)!

To enjoy the shade an awning can provide, follow these steps:

1. Release the travel locks and loosen the tightening wheels on both arms

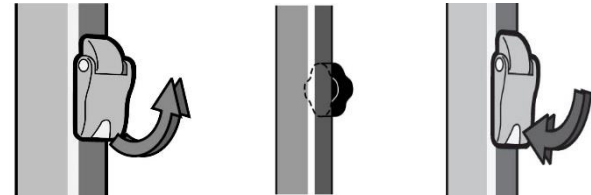

2. Flip the release lever at the roller tube to the 'roll down' position, using the pull rod

3. Pull the pull strap using the pull rod. Do not release the awning pull strap.

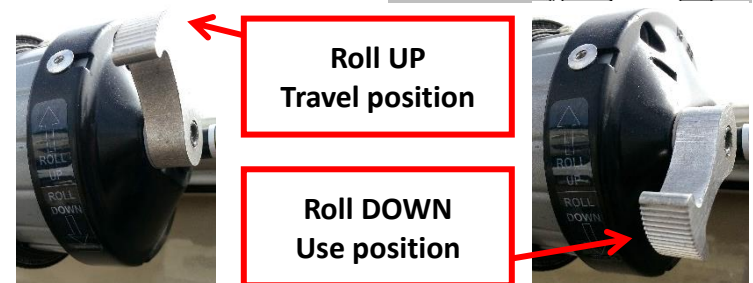
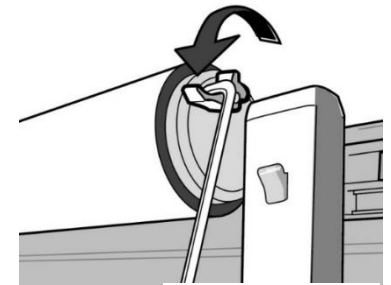

4. Once the awning is rolled out all the way, move the rafter arms all the way out to the roller tube, stretch the fabric and secure the tightening wheels.

- To raise the awning up, fold out the handle on the awning arm and pull up to the desired height. Ensure the latching mechanism is properly engaged before letting go



NEVER release the awning arms from the wall brackets at any time!

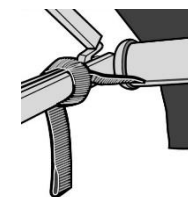
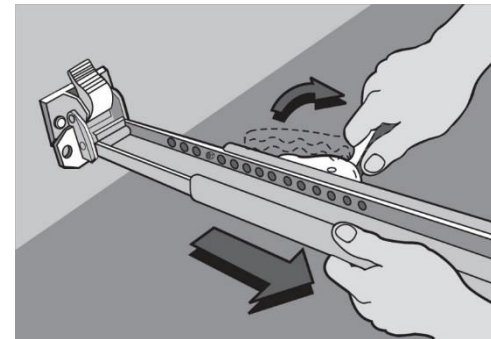

To keep the awning pull strap from getting dirty or lost, wrap it loosely around the awning arm closest to the release lever

To roll up the awning into the travel position have a 2nd person to assist. Center the strap and pull. Hold on tight! The 2nd person flips the release lever. Slowly let the awning roll up – using the pull rod. Ensure the travel locks are engaged and the tightening wheels are tight

Ensure the release lever at the roller tube is in the 'ROLL UP' position - use the pull rod to adjust if needed



CAUTION: When it is windy or rainy, retract and roll-up the awning!

Remember – Weather conditions can change rapidly.
Especially in the desert and mountains!



Before driving off – ensure the awning is properly secured

AWNING – Electric



Before rolling out the awning, ensure there is enough space to fully extend it and that it does not interfere with tree branches, etc.



NEVER leave the awning open in windy conditions or rainy weather!

NEVER leave the awning unattended (absence or overnight)!



Rolling Up

Unrolling

Do NOT unroll too far - Ensure the awning rolls up the correct way – fabric over the top of the roll.

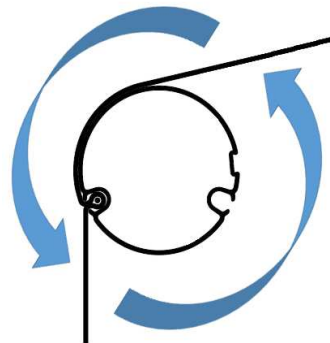
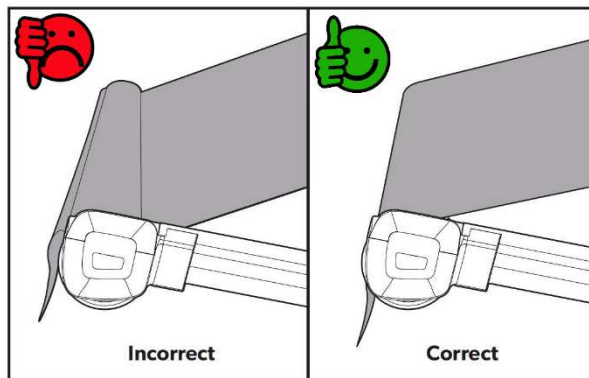

Rolling Up

ALWAYS ROLL UP!

IMMER AUFROLLEN!

Coachmen Leprechaun vehicles:

Make sure the knobs are NOT tight – just snug – before rolling the awning up.

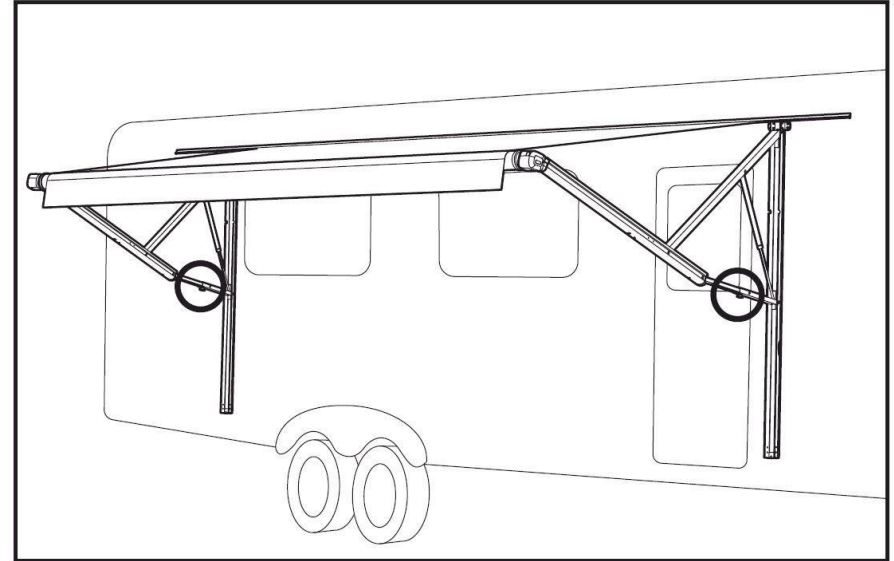

CAUTION: When it is windy or rainy, retract and roll-up the awning!

Remember – Weather conditions can change rapidly.
Especially in the desert and mountains!

Before driving off – ensure the awning is fully rolled up

SETTING UP AND BREAKING DOWN CAMP



When you arrive at the camp site

1. Have a passenger guide you into the camp site to prevent hitting an obstacle and damage the vehicle
2. Park the motor home on a level surface. Otherwise use the levelers to level the vehicle from front to back and side to side (see page 50 – Refrigerator)
3. Apply the parking brake before shifting into park
4. Before extending the slide room(s) make sure there is enough clearance
5. If equipped – extend the entry step (turn off the electrical step, so it remains extended)
6. Hook up the power cord, fresh water and sewer hose
7. Turn on air conditioner or heater – as needed
8. Turn on water heater

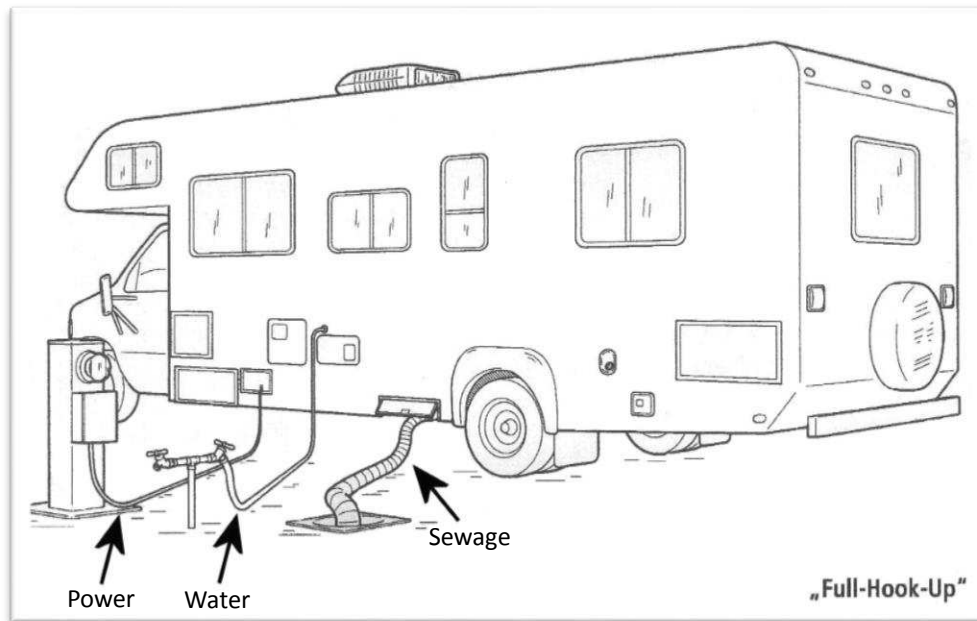

Before leaving the camp site

1. Roll up and secure the awning
2. Retract the slide room(s)
3. Close all roof vents and windows
4. Turn off the air conditioner/heater
5. Turn off the water heater and water pump
6. Unplug and store the power cord and TV cable
7. Disconnect and store the fresh water hose
8. Close dumping valves, disconnect and rinse the sewer hose and store it. Put the sewer cap on
9. Release the parking brake and drive motor home off levelers
10. Put levelers in storage
11. Close and lock all compartment doors
12. If equipped – retract the entry step (turn on electrical step, so it retracts when closing the door)
13. Lock the entry door
14. Secure any loose items in the motor home
15. Close all drawers and cabinets inside the motor home
16. Ensure everybody is wearing seat belts
17. Drive carefully on the campground and roads – request help from a passenger in narrow spots

For safety reasons Road Bear RV / Britz USA does not recommend 'street-side' camping, which is illegal in some states

MEASUREMENT CONVERSIONS

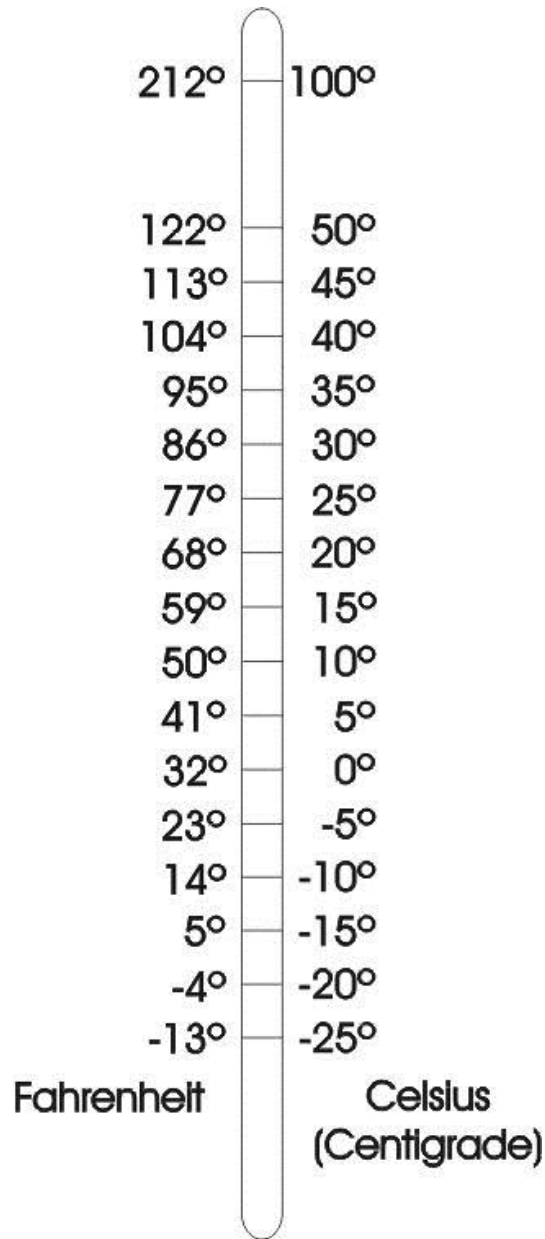

Length	
1 Kilometer (km)	0.621 miles
1 Meter (m)	3.28 feet
1 mile (mi) / 5730 feet	1.609 kilometers
1 foot (ft.)	30.48 centimeters
1 inch (in)	2.54 centimeter
Liquids	
1 gallon (gal)	3.78 liters
1 quart (qt.)	0.94 liters
1 ounce (fl. oz.)	0.03 liter
1 liter (lt.)	0.264 gallons
Weight	
1 kilogram (kg)	2.205 pounds
1 ounce (oz.)	28.35 grams
1 pound (lb.)	453 grams
1 ton (t) / 2000 lbs.	906 kilograms
Speed	
35 miles per hour (mph)	56 kilometers per hour
45 miles per hour (mph)	72 kilometers per hour
55 miles per hour (mph)	88 kilometers per hour
65 miles per hour (mph)	105 kilometers per hour
75 miles per hour (mph)	120 kilometers per hour

VEHICLE SPECIFICATIONS

ALL MEASUREMENTS ARE APPROXIMATE, NOT GUARANTEED AND MAY BE DIFFERENT FOR INDIVIDUAL VEHICLES
AND MAY CHANGE ANY TIME WITHOUT PRIOR NOTICE!

Model	U-; Class A	R-; Class C	P-; Class C	M-; Class C	L-; Class C
	30-32 ft. / 9.1-9.8 m	28-30 ft. / 8.5-9.2 m	25-27 ft. / 7.6-8.3 m	22-24 ft. / 6.7-7.4 m	21-23 ft. / 6.4-7.1 m
Gross Vehicle Weight	18,000 lbs. / 8154 kg	14,500 lbs. / 6568 kg	14,500 lbs. / 6568 kg	12,500 lbs. / 5662 kg	10,360 lbs. / 4693 kg
Fuel - Gasoline	Minimum 89 octane or higher unleaded gasoline – NO DIESEL				
Motor & Generator oil	Noted on filler cap (if not available: 5W-30 acceptable)				
Coolant / Anti-freeze	Red or yellow in color – fill only with drinking water!				
Tire pressure	See information near driver seat / on door jamb – Blue label with Ford logo				
Automatic transmission	6 gears with tow/haul mode				
Engine Type / Size	Gasoline V-10 / 6.8L				Gasoline V-6 / 3.7L
Engine Power	320 HP / 324 PS	305 HP / 309 PS			275 HP / 278 PS
Engine Torque	460 ft-lb / 623 Nm	420 ft-lb / 569 Nm			260 ft-lb / 352 Nm
Fuel tank capacity	80 gal / 302 liters	55 gal / 210 liters			25 gal / 95 liters
Fuel consumption	5-8 mpg / 30-45 l/100km	7-10 miles per gallon / 25-35 l/100 km			9-12 mpg / 19-26 l/100km
Required width clearance	10'10" / 330 cm	10'6" / 320 cm			9'5" / 290 cm
Required vertical (height) clearance	13' / 396 cm	12' / 365 cm			
Interior height	7' / 213 cm	6'10" / 208 cm			6'9" / 205 cm
Microwave volume	0.9 - 1.2 cu ft. / 25 - 34 liters				
Refrigerator volume	6 - 7 cu ft. / 170 - 198 liters				
Allowable city water pressure	45 Pound Square Inch / 3.1 bar				
Electricity power supply	120 Volt AC, 60 Hz, 30 Amp				
Water heater capacity	6 gallons / 22 liters; about 20 – 30 minutes until hot water is available				
Fresh water capacity	50 gal / 189 liters	40-48 gal / 151-180 liters	40-56 gal / 151-210 liters	40-56 gal / 151-210 liters	38 gal / 143 liters
Grey water capacity	40-44 gal / 151-166 liters	28-31 gal / 105-117 liters	25-28 gal / 94-105 liters	28-38 gal / 105-143 liters	2x 21 gal / 2x 79 liters
Black water capacity	40 gal / 151 liters	26 gal / 98 liters	22-26 gal / 83-98 liters	22-25 gal / 83-95 liters	28 gal / 106 liters
Propane tank Fill capacity is limited to 80%	20 gal / 74 liters	12-16 gal / 45-60 liters	12-16 gal / 45-60 liters	10-16 gal / 37-60 liters	10 gal / 37 liters

RETURNING THE MOTORHOME AT THE END OF YOUR TRIP

1. **RETURN** the motorhome between **8:00** and **10:30 a.m.** If you do not require the transfer to the airport or airport hotels, return no later than 11:00 a.m. If the motorhome has any damage, please return before 09:30 a.m.



2. **BEFORE** returning to Road Bear RV; at the last campground or overnight stop:



a. **Dispose** of any left-over food and trash



b. **Pack** your personal belongings and luggage

c. **Clean** the inside (wipe clean the shower, toilet, sinks, refrigerator, stove, oven, microwave; wash the dishes, pots, pans, and coffeemaker) and sweep out the motorhome



d. **Drain** the waste water tanks. **Tanks must be empty!**

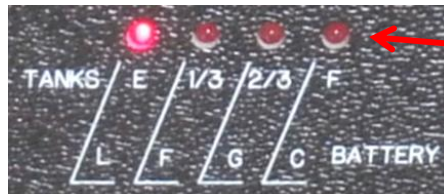
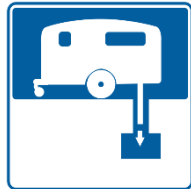

Tank Display shows "E" when empty

3. Fuel and propane tanks need to be **FULL** (verify the tank indicators!)

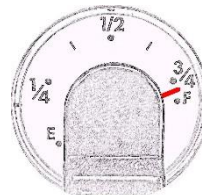
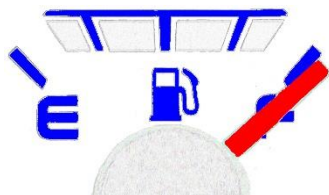

4. At Road Bear RV:
 - a. Please unload all linens and camping chairs and put them in their designated return areas
 - b. Please unlock all exterior compartment doors
 - c. Check all storage areas and cabinets, remove all personal items. Items left behind will be discarded after 14 days
 - d. Let our office staff know that you are ready for the check-in

COMPLEMENTARY SHUTTLE SERVICE



The vehicle return has to be concluded by 10.30 a.m. for the transfer. The shuttle transfer to the airport or airport hotels departs Road Bear RV at 11:00 a.m. only – there are no other shuttle runs!

If you require a taxi to an alternate location or for an early flight, please contact the return location in advance.



There is no shuttle service for late returns!
Shuttle service is only once a day (11:00 a.m.)

MINIMUM CHARGES

- Late charges: US\$ US\$300.00 plus direct customer daily rate
- Gasoline: As calculated upon return plus a handling fee
- Propane: As calculated upon return plus a handling fee
- Dumping: up to US\$ 75.00
- Cleaning Fee: US\$ 50.00 minimum; US\$ 250.00 minimum for smoking & pets



RENTAL LOCATION ADDRESS LISTINGS



Business Hours:

Monday – Friday 8:00 AM – 5:00 PM Saturday 8:00 AM – 1:00 PM (by appointment)
 Sundays & Holidays closed (New Year’s Day, Presidents Day; Memorial Day; 4th of July; Labor Day; Thanksgiving Day, Christmas Day)

Dallas (DFW) (drop-off only!)	3500 S Central Expy	McKinney, TX 75070	Tel: 1-818-865-2925	Toll free: 1-866-491-9853
		34 miles / 55 km from DFW airport – No public transport access – No shuttle service provided		
Denver (DEN)	7685 Dahlia Street	Commerce City, CO 80022	Tel: 1-720-570-1100	Toll free: 1-866-457-1100
		22 miles / 35 km from DEN airport – No public transport access		
Las Vegas (LAS)	4730 Boulder Highway	Las Vegas, NV 89121	Tel: 1-702-453-1109	Toll free: 1-866-303-1057
		8 miles / 13 km from LAS airport – Impractical public transport access		
Los Angeles (LAX)	28404 Roadside Drive	Agoura Hills, CA 91301	Tel: 1-818-991-2794	Toll free: 1-866-527-6876
		36 miles / 58 km from LAX airport – Impractical public transport access		
New York (NYC)	42 State Route 36 East	North Middletown, NJ 07748	Tel: 1-732-495-0959	Toll free: 1-866-787-3682
		33 miles / 53 km from EWR airport - NJ TRANSIT train between Middletown and EWR & Manhattan / Ferry between Belford/Harbor Way and Manhattan – Free transfer to & from train station/ferry terminal offered <u>with prior appointment only</u>		
Orlando (MCO)	3800 W Colonial Drive	Orlando, FL 32808	Tel: 1-407-384-9241	Toll free: 1-855-926-8727
		17 miles / 27 km from MCO airport – Impractical public transport access		
San Francisco (SFO)	420 San Leandro Blvd	San Leandro, CA 94577	Tel: 1-510-564-4444	Toll free: 1-866-249-1119
		30 miles / 48 km from SFO airport – BART (train) to/from downtown & airport		
Seattle (SEA)	1541 South 96 th Street	Seattle, WA 98108	Tel: 1-206-334-7303	Toll free: 1-855-732-1541
		7 miles / 11 km from SEA-TAC airport – Bus 132 stop Des Moines Memorial Drive S at S 96 th St		

For maps visit the [Road Bear RV website](http://www.roadbearrv.com/en/contact-us/branch-locations)¹ or [Google Maps](https://maps.google.com)²

¹ <http://www.roadbearrv.com/en/contact-us/branch-locations>

² <https://maps.google.com>